



**KYSTVERKET**

# Fritidsbåt konferanse

Sjøfartsdirektoratet

Haugesund 27-28.03.2014



Vakkert  
Variert  
Værhardt

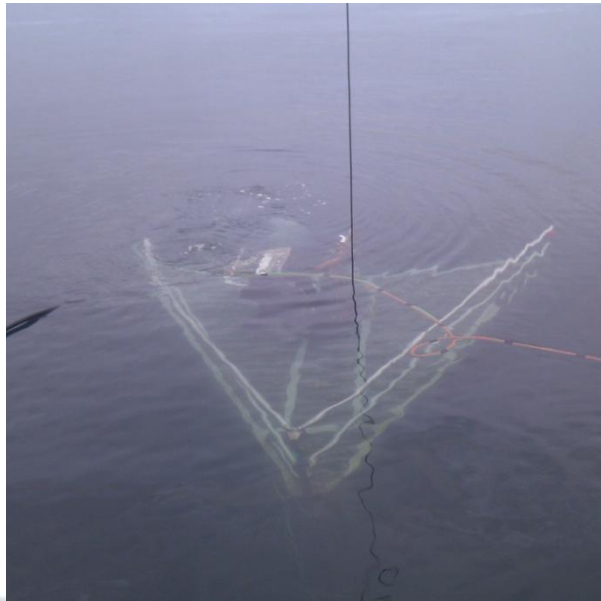

# IALA maritime buoyage system (region A)

## Havne og farvannsloven

## Forskrift om navigasjonsinnretninger

## Retningslinjer utforming/krav navigasjonsinnretninger



**KYSTVERKET**  
– trykker og utvikler  
kysten for alle

### SJØMERKESYSTEMET I NORGE

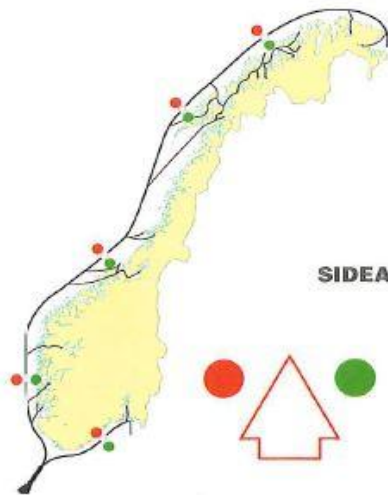

#### FRITTLIGGENDE GRUNNER/FARER



#### SPESIALMERKER



#### SIDEAVMERKING - LATERALMERKER

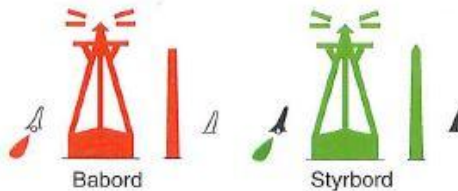

#### KOMPASSAVMERKING

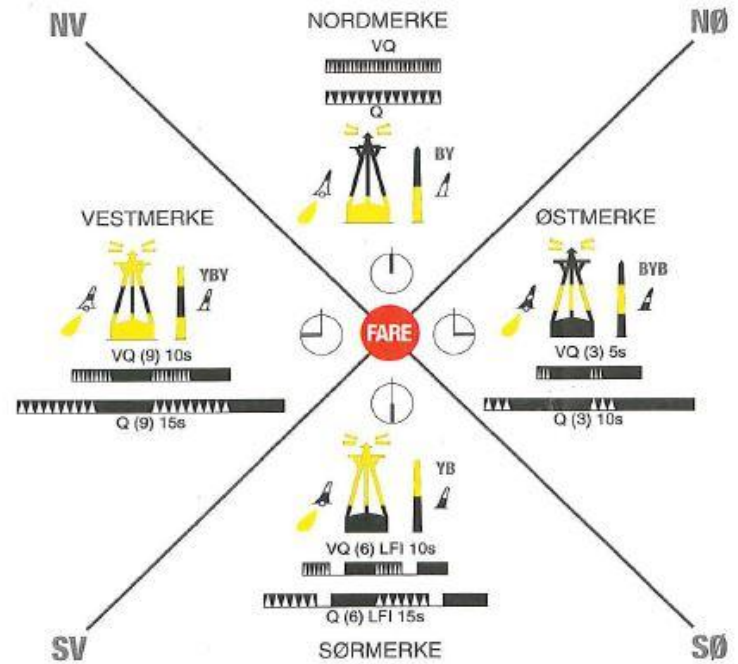

Utgitt i samarbeid med Sjøfartsdirektoratet



KYSTVERKET

www.kystverket.no

# Standard fyrlykt

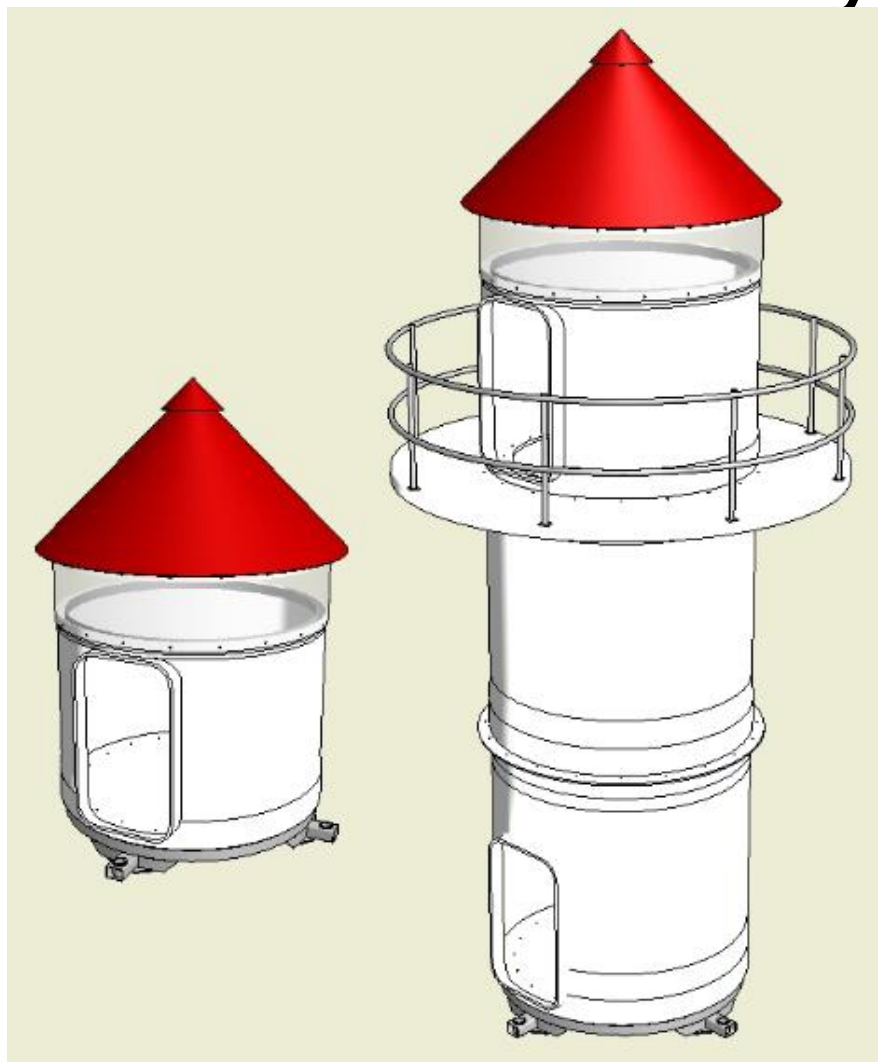

Flere mål oppnådd:

*Ingen blindsoner ved skjerming*

*Modulbasert*

*Monteringsvennlig*

*"Vedlikeholdsfri"*





Vi har litt over 12000 merkestenger (i stål)



# Utvikling innen merking



# Kompositt materialer

- Enklere montering
- Billigere
- Mindre vedlikehold
- Lettere
- Sikrere (HMS)

## LED lysteknologi

- Større driftssikkerhet
- Uavhengig av landstrøm  
(som oftest)
- Mindre vedlikehold
- Mindre strømtrekk



# Mini-HIB på Nørve





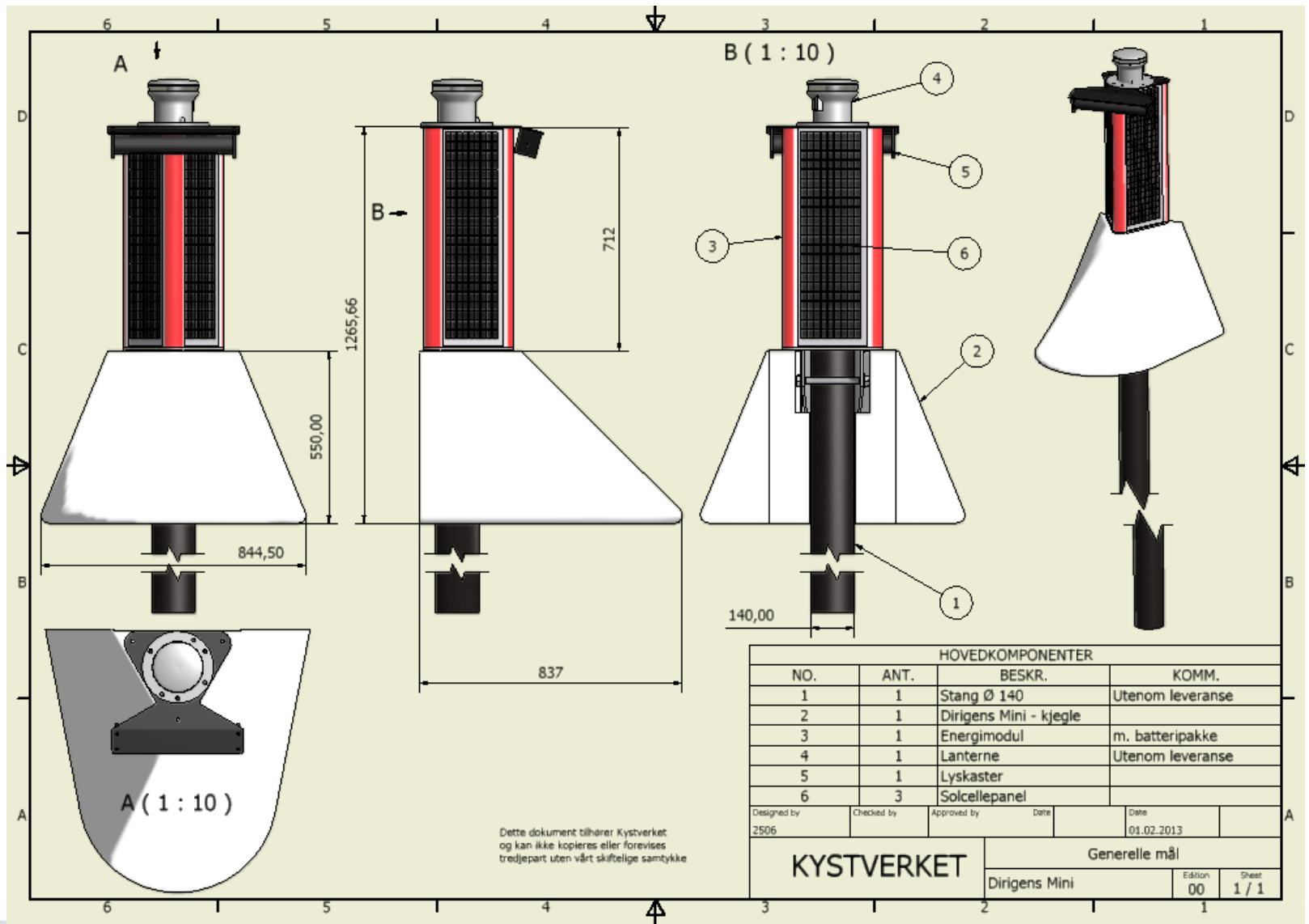



KYSTVERKET

[www.kystverket.no](http://www.kystverket.no)

# Fritidsflåten

- Sørlandsleia (tilpasset oppmerking)
- Rakkebåene
- Side-leder
  - (lede fritidstrafikk ut led til yrkestrafikk)
- Særskilte fritidsprosjekter





# Rakkebåene

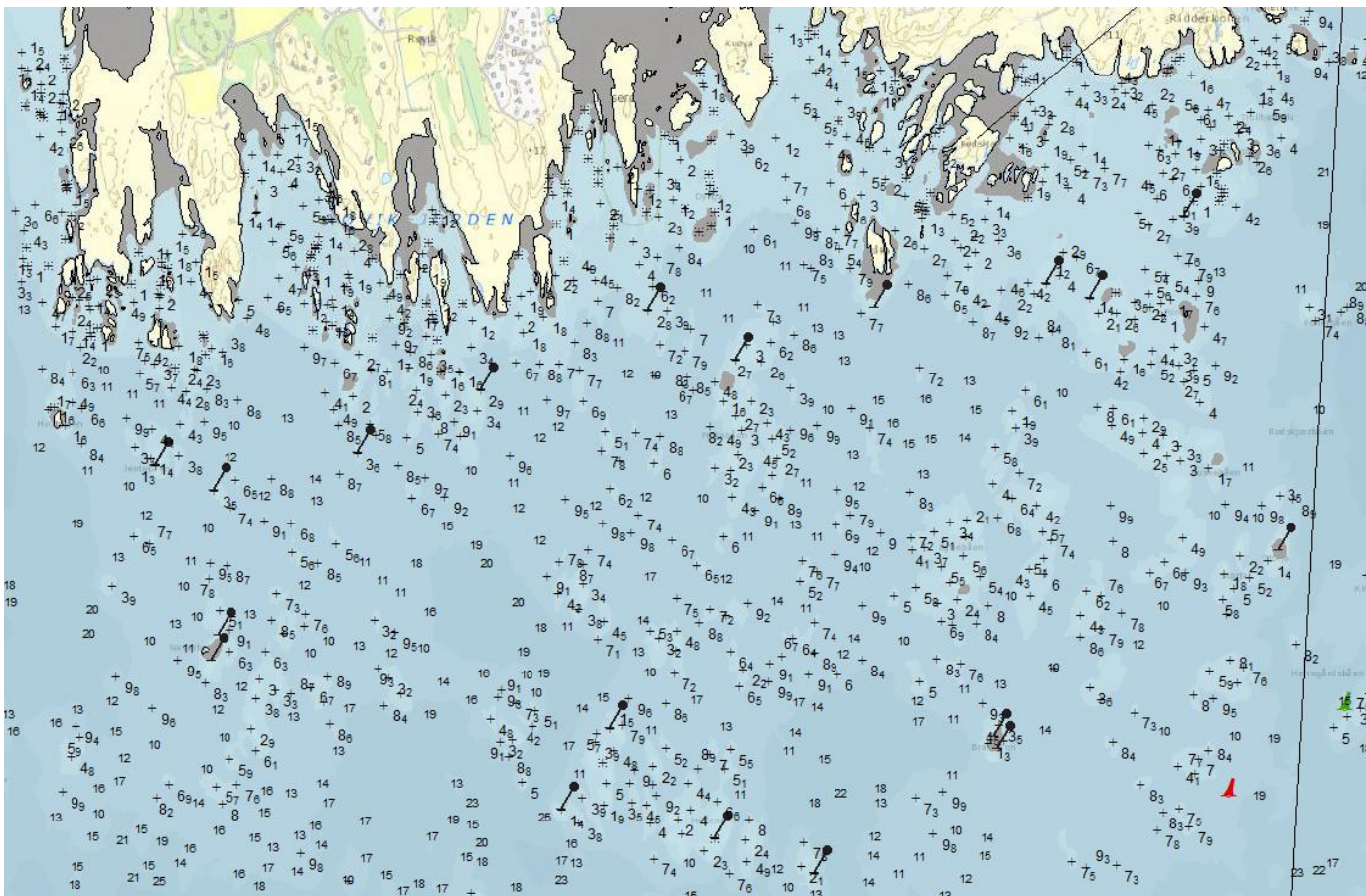

Totalt skal 15 jernstenger med refleks og retningsviser settes opp. Halvparten av dette ble utført i 2013, resterende i 2014.





# Godkjenning av private navigasjonsinnretninger

- ”Noen” innretninger i indre led er av non-IALA standard, dvs. gamle/private
- Regioner er delegert myndighet iht. HFL for nye tiltak innad i Kystverket
- Private henvises til regionene for godkjenning
- Private har ansvar etter HFL for vedlikehold og drift av egne innretninger



Takk for oppmerksomheten



Testobjekt Svalbard



KYSTVERKET

[www.kystverket.no](http://www.kystverket.no)