

Regulations of 22 November 2013 No. 1404 on fishing vessels of less than 15 meters in overall length

Legal basis: Laid down by the Norwegian Maritime Authority on 22 November 2013 under the Act of 16 February 2007 No. 9 relating to ship safety and security (Ship Safety and Security Act) sections 6, 9, 11, 12, 13, 14, 21, 22, 41, 43 and 47, cf. Formal Delegation of 16 February 2007 No. 171 and Formal Delegation of 31 May 2007 No. 590.

EEA references: Notification of technical regulations has been sent for public consultation in the EEA in accordance with the Act on European notification of technical rules, etc. (the EEA Hearing Act) sections 4 and 5, cf. Regulations of 16 August 2016 No. 983. The standstill obligation is repealed on 17 November 2016.

Amendments: Amended by Regulations of 4 May 2015 No. 445, 16 August 2016 No. 983 (EEA Hearing), 30 August 2017 No. 1347 (confirmation following completed EEA Hearing), 20 December 2017 No. 2379, 13 July 2018 No. 1191, 26 October 2020 No. 2142, 6 December 2021 No. 3415 as amended by Regulation of 29 December 2021 No. 3914 (in force on 1 January 2022), 27 March 2023 No. 459.

1. General provisions

Section 1. *Scope of application*

These Regulations apply to Norwegian fishing vessels of less than 15 metres in overall length.

0 Amended by Regulation of 6 December 2021 No. 3415 (in force on 1 January 2022).

Section 2. *Definitions*

For the purpose of these Regulations, the following definitions shall apply:

- a. "accepted electrical enterprise": an electrical enterprise accepted by the Norwegian Directorate for Civil Protection to carry out inspections of electrical installations on board fishing vessels;
- b. "existing vessel": a vessel which is not a new vessel;
- c. "fishing vessel": a vessel equipped and used commercially for catching fish and marine mammals, as well as to harvest seaweed and sea tangle or other living resources of the sea;
- d. "angle of flooding θ_f ": the angle of heel at which openings in the hull, superstructure or deckhouse that cannot rapidly be closed weathertight begin to submerge. Small openings, for instance for passing wires, chains, etc. need not be considered open if immersion takes place at an angle of heel of 30 degrees or more;
- e. "approved company": a company approved by the Norwegian Maritime Authority to carry out inspections in accordance with these Regulations;
- f. "new vessel": a vessel for which the building contract or a contract regarding major conversion is placed or the actual execution thereof has commenced, in the form of keel laying or equivalent, after 1 July 2014;
- g. "Nordic Boat Standard (1990)": Nordic Boat Standard for Commercial Boats less than 15 metres, 1990;
- h. "type-approved": equipment which is type-approved by a Notified Body and marked in accordance with Regulations of 30 August 2016 No. 1042 on marine equipment or approved, type-approved by the Norwegian Maritime Authority, with the exception of radio installations which shall be approved in line with the provisions of section 67;
- i. "lifting equipment":
 - lifting appliances, including loading and unloading appliances
 - lifting tools, including loading and unloading gear
 - lifting componentsused together or individually.

0 Amended by Regulations of 20 December 2017 No. 2379 (in force on 1 January 2018), 6 December 2021 No. 3415 (in force on 1 January 2022).

2. Construction

Section 3. *Scope of application of this chapter*

(1) This chapter applies to vessels of 6 to 15 meters in overall length, constructed after 1 January 1992.

(2) Vessels constructed before 1 January 1992 shall comply with the vessel requirements applicable at the time of construction of the vessel. Such provisions need nevertheless not be enforced more rigorously than laid down in these Regulations, provided that due consideration is given to maintaining safety standards.

(3) When a vessel is substantially altered or modified, the vessel shall comply with the requirements for a new vessel.

0 Amended by Regulation of 4 May 2015 No. 445 (in force on 6 May 2015).

Section 4. Construction requirements

(1) Vessels shall be constructed, dimensioned and equipped in accordance with the Nordic Boat Standard (1990) unless otherwise provided by the individual provisions. Alternatively, a complete set of recognised rules or another standard may be used when the safety standard is equivalent to the Nordic Boat Standard (1990). In cases of doubt, the Norwegian Maritime Authority may determine whether the rules are equivalent to the Nordic Boat Standard (1990).

(2) The combination of different types of construction material is not permitted in the exterior hull below the loaded waterline.

(3) Vessels constructed before 1 March 2007 that appear structurally intact, shall be considered to satisfy the requirement of the first paragraph if the watertight subdivision, bilge system, means of closure, freeing port area, bow height and freeboard satisfy the requirements of Nordic Boat Standard (1990).

(4) The hull of vessels intended for trade in ice shall be strengthened in accordance with the anticipated conditions of navigation, cf. Nordic Boat Standard (1990) C33.

(5) Lifting equipment with a lifting capacity of more than 500 kg or more than two ton metres shall irrespective of the vessel's year of construction comply with the requirements of Regulations of 17 January 1978 No. 4 and be certified by a competent person. Lifting equipment used in open waters shall be certified in accordance with the Regulations of 13 January 1986 No. 31 on cranes used on ships in open waters for loading and unloading.

(6) Lifting equipment with a lifting capacity of up to and including 500 kg or more than two ton metres shall, regardless of whether or not the lifting equipment is power-operated and irrespective of the vessel's year of construction, comply with the following:

- a. The lifting equipment is permanently marked with the permitted safe working load (SWL) based on information from the manufacturer or calculations made by a competent person.
- b. An overload test of the lifting arrangement equivalent to 1.25 x SWL shall be carried out.
- c. The lifting equipment shall be dimensioned based on the maximum lifting capacity of the lifting equipment with a safety factor of 4.5 against breakage.
- d. Wire ropes, hooks, shackles, blocks, swivels, rings, etc. shall be dimensioned with a safety factor of 5 against breakage.
- e. Ropes shall have a safety factor of 7 against breakage.
- f. Ropes may be used as mantles/hoisting ropes when this has been specified by the crane manufacturer. Ropes shall be suitable for the purpose and comply with the supplier's guidelines concerning use and disposal.

0 Amended by Regulation of 6 December 2021 No. 3415 (in force on 1 January 2022).

Section 5a Trawl, purse-seine, power-operated block and Danish seine arrangements

(1) Arrangements and their components and equipment shall be dimensioned and arranged in accordance with good practice and under the supervision of a person who has experience and qualifications with the relevant type of equipment.

(2) As from 1 January 2023, an approved company shall check that blocks, shackles and other loose equipment are dimensioned in accordance with the Regulations on cargo-handling appliances on ships. This requirement is applicable in connection with initial inspections of vessels and, subsequently, inspections carried out every 5 years for fishing vessels of 9 metres or more in overall length.

(3) On arrangements installed after 1 January 2023, trawl winches shall be so arranged that the desired traction force can be adjusted and slackening of the trawl wire shall be possible if the pre-set traction force is exceeded. It shall not be possible to lock the trawl wire while trawling.

(4) On arrangements installed after 1 January 2023, a hydraulically operated suspension arrangement for the power-operated block shall be so arranged that a failure in the oil supply or ruptured hoses, etc. does not cause the arrangement to fall down in an uncontrolled manner.

0 Added by Regulation of 6 December 2021 No. 3415 (in force on 1 January 2022).

Section 6. *Bulwarks, rails and guards*

Vessels of 6 to 15 meters in overall length constructed after 1 July 2014 shall have bulwarks or guard rails with a height of minimum one metre on all exposed parts of the working decks and on superstructures functioning as a work station. The height may be reduced to minimum 600 millimetres if it hinders the execution of the fishing and it is considered absolutely necessary.

3. Fire, machinery and electric installations

Section 7. *Scope of application of this chapter*

- (1) This chapter applies to vessels constructed after 2 January 1988.
- (2) Vessels constructed before 2 January 1988 shall be constructed and equipped in accordance with the rules applicable at the time of construction of the vessel, unless otherwise provided by the individual provisions of this chapter.
- (3) When a vessel is substantially altered or modified, the vessel shall comply with the requirements for a new vessel.

0 Amended by Regulation of 4 May 2015 No. 445 (in force on 6 May 2015).

Section 8. *Fire safety*

- (1) Vessels constructed after 1 January 1992 shall have structural fire protection in accordance with chapter C14 of Nordic Boat Standard (1990), unless otherwise provided by the individual provisions of this chapter.
- (2) Vessels constructed before 1 January 1992 shall have structural fire protection in accordance with the rules applicable at the time of construction of the vessel.
- (3) Irrespective of the year of construction of the vessel, gasfired installations shall satisfy the requirements of Regulations of 20 October 1983 No. 1580 on safety precautions for gasfired installations, etc. operating on propane or other liquefied hydrocarbon gases used on board vessels.

Section 9. *Oil-fired stoves*

- (1) Stoves with electric power supply shall have an oil supply which shuts off automatically if:
 - a. the stove is over-heated (maximum 400°C in smoke gas);
 - b. the flame goes out;
 - c. a failure occurs in the supply of air or power.
- (2) Stoves without electric power supply shall have an oil supply which shuts off automatically if:
 - a. the stove is over-heated (maximum 400°C in smoke gas);
 - b. the flame goes out.
- (3) Drip regulation stoves (regulation valve with observation hole) need not have automatic shutoff of the oil supply if the flame will go out due to the oil consumption being limited by an oil regulation valve. The installation instructions shall indicate the maximum permitted difference in height between the oil tank and the regulation valve. An oil pressure reduction valve shall be fitted if satisfactory regulation of the oil supply cannot be achieved through pressure variations. The overflow system shall be capable of receiving the full volume of the tank.
- (4) The resetting of the safety function shall be manual.
- (5) The installation instructions shall be kept on board. The instructions for use shall be posted near the stove.
- (6) Stoves with accessories shall be installed in accordance with the installation instructions from the manufacturer.

(7) Stoves shall have smoke outlet to uptake.

Section 10. *Installation, etc. of oilfired stove*

- (1) Stoves shall be securely fixed to the floor or to a fixed bench, if possible near the centre line of the vessel.
- (2) Stoves without automatic shutoff of oil supply in the event of the flame going out, shall be provided with a separate oil tank of maximum 40 litres. The oil tank shall not be filled automatically, and shall be placed on the height indicated in the installation instructions.
- (3) The oil tank shall have a water separator and a plug for draining off possible collection of water and shall be placed outside the space where the stove is installed.
- (4) The oil pipe to the regulator shall have a filter for the separation of mud and water. The filter shall not be fitted above the stove.
- (5) Pipes made of copper or equivalent material shall be used between the tank and the stove. The pipes shall be fixed and placed so as to prevent the formation of air pockets.
- (6) Stoves shall have overflow openings with drain pipes and collection tank. Both the stove and the float valve, if used, shall be connected to the collection tank.
- (7) Smoke uptake pipes shall have a diameter which is not less than the smoke outlet of the stove, and the piping shall be made as straight as possible.
- (8) Drainage of condensed water/mud, cleaning of filters, inspection of burners and other components shall be carried out in the time intervals stipulated in the operating instructions.
- (9) Spaces with a stove shall be well ventilated.
- (10) On vessels of 8 to 15 metres in overall length the stove shall be inspected by an approved company within six months of being installed.

Section 11. *Insulation of fireplaces, etc.*

- (1) Bulkheads shall be insulated with non-combustible material in accordance with Appendix 4.
- (2) Below stoves, wooden floor or combustible floor covering shall be protected by steel or aluminium sheets covering the whole floor area under the fireplace and in front of the stove at least 15 cm from the fire door. Where the stove is placed on a bench or similar, the bench shall be protected by non-combustible material.

Section 12. *Smoke uptake and exhaust pipes*

- (1) Smoke uptakes and exhaust pipes shall consist of at least 3 mm thick steel plates and shall be securely fixed. Smoke uptakes shall be carried at least 1.3 m above deck.
- (2) Saucer formed rockwool sheets of at least 6 cm thickness shall be provided between smoke uptake and combustible material. Insulation in the form of non-combustible material shall be provided between metal cover plates and combustible material. Alternatively, a pipe with a diameter at least 6 cm larger than the smoke uptake pipe may be fitted outside this pipe, in order to provide vertical air circulation between the pipes. Insulation by saucer formed rockwool or mineral wool twine of at least 3 cm thickness shall be provided between the outer pipe and combustible material. The pipe shall be carried to at least 1 m above the deck, and the outlet shall be protected with a collar.
- (3) When smoke uptake is carried along a bulkhead, the bulkhead shall be insulated with non-combustible material. Smoke uptakes shall not be placed closer than 10 cm to insulated bulkheads. Where the smoke uptake (pipe) is insulated with saucer formed rockwool or mineral wool twine of at least 2 cm thickness, the distance to the insulated bulkhead may be reduced to 5 cm.
- (4) Any exhaust manifold which is not watercooled, and parts of exhaust pipes which may cause ignition, shall be insulated so that oil cannot penetrate. Where gases are watercooled, other arrangements may be accepted. Exhaust pipes shall not be closer than 2 cm to combustible material.
- (5) Oil pipes shall be placed as far as possible away from exhaust pipes and hot engine parts.

Section 13. *Insulation with non-combustible material*

Non-combustible material means a material which, when tested and evaluated in accordance with MSC.61(67) (the FTP Code), satisfies the requirements for qualifying materials as non-combustible. The insulation shall, if necessary in order to preserve the fire-insulating effect, be mounted with a sheet of galvanized steel or aluminium.

Section 14. *Insulation of machinery spaces in wooden vessels*

- (1) Machinery spaces in new and existing wooden vessels shall have floors of steel or aluminium plates. Machinery spaces shall be insulated with non-combustible material or have an approved fire-extinguishing system.
- (2) In machinery spaces without inside planking, wooden casings, beams and surfaces under deck as well as bulkheads forwards and aft in the machinery space shall be insulated with non-combustible material.
- (3) In machinery spaces with inside planking, all woodwork shall be insulated with non-combustible material down to the lower edge of the floor. No insulation is required behind fuel oil tanks if the other insulation is fitted tightly around the tank.
- (4) In vessels where the engine is not placed in a separate compartment, all combustible material which is exposed to heat from exhaust manifolds, exhaust pipes, etc. shall be insulated with non-combustible material. When an engine cover is used, this shall be insulated on the inside and be mounted with a galvanized steel or aluminium sheet.

0 Amended by Regulation of 6 December 2021 No. 3415 (in force on 1 January 2022).

Section 15. *Fire-extinguishing systems in machinery spaces*

- (1) New and existing vessels with inboard engines shall have fixed fire-extinguishing systems in machinery spaces.
- (2) For vessels of between 10.67 and 15 metres in overall length, the following shall apply:
 - a. The extinguishing medium shall be of an approved type.
 - b. The amount of extinguishing medium is determined in each individual case depending on the size of the machinery space.
 - c. The fire-extinguishing system shall only be capable of being released from outside the machinery space. The release cabinet shall be clearly marked, provided with instructions for use and protected against unintentional release.
 - d. CO₂ containers and other containers for extinguishing gas which could be hazardous in the event of a leak, and appurtenant release device, shall be placed in a separate clearly marked space/locker outside the machinery space.
 - e. Gastight bulkheads shall be provided to adjacent spaces and entrance from open deck. An alarm signal shall sound automatically when the release cabinet is opened. The release cabinet for activation of CO₂ shall have ventilation to the open air.
- (3) New and existing vessels of less than 10.67 metres in overall length may as an alternative to requirements of the second section be equipped with a fire-extinguishing system with automatic release.
- (4) The alternative that is allowed for in the third paragraph must satisfy the following functional requirements:
 - a. The system is suitable for use on board the vessel.
 - b. The system is suitable for extinguishing fires in machinery spaces.
 - c. The system does not pose a hazard to personal safety.
 - d. The system covers the area to be protected (machinery space volume).
- (5) A fire-extinguishing system pursuant to the third paragraph shall be installed, used and maintained in accordance with the guidelines of the supplier.
- (6) Vessels constructed between 1 January 1992 and 1 January 2022 may, as an alternative to the requirement of the third paragraph, cf. the fourth paragraph, be equipped with a fire-extinguishing system in accordance with guidelines laid down in chapter C14 of Nordic Boat Standard (1990).

0 Amended by Regulation of 6 December 2021 No. 3415 (in force on 1 January 2022).

Section 16. *Fire detection and alarm system*

(1) Vessels of 10.67 to 15 metres in overall length, irrespective of year of construction, shall have fire detection system and fire alarm system for machinery spaces and smoke alarm system for the cabins in accordance with Appendix 5.

(2) Vessels of less than 10.67 meters in overall length shall, irrespective of year of construction, be fitted with at least one smoke and heat detector in machinery spaces, at least one smoke detector in recreational spaces and at least one smoke detector in the wheelhouse. Vessels constructed after 1 January 2022 shall have type-approved detectors.

0 Amended by Regulation of 6 December 2021 No. 3415 (in force on 1 January 2022).

Section 17. *Fire extinguishers*

(1) All vessels shall, irrespective of year of construction, have at least two type-approved fire extinguishers of at least 6 kg. At least one fire extinguisher shall be installed at a suitable location outside machinery spaces and at least one fire extinguisher shall be placed in accommodation spaces.

(1) Fire extinguishers with pressurised extinguishing medium shall not be placed in accommodation spaces. Fire extinguishers which may be exposed to frost shall be of a frost-proof type.

(3) At least one spare charge shall be provided for each extinguisher. If the extinguisher is of a type that cannot be charged on board, the number of extinguishers shall be increased by 50 per cent.

(4) Fire extinguishers shall be inspected annually in accordance with NS3910. The date of the inspection shall be marked on the extinguisher.

0 Amended by Regulations of 4 May 2015 No. 445 (in force on 6 May 2015), 6 December 2021 No. 3415 (in force on 1 January 2022).

Section 18. *Ventilation systems*

The vessel's machinery space shall have at least two ventilators capable of being closed from deck. Cabins shall have at least two ventilators with a diameter of at least 8 cm.

Section 19. *Materials, etc.*

Materials, varnishes, paints, etc. produced on a nitrocellulose basis or any other basis which will readily ignite are not permitted to be used anywhere on board.

Section 20. *Storage of oil fuel and other flammable liquids*

(1) Oil fuel shall be stored in tanks of steel or equivalent material.

(2) Outlets from oil fuel tanks shall be fitted with a closing valve or cock on the tank itself, which is capable of being closed from the deck. Test cocks and cocks for oil gauge glass shall be of a self-closing type. The tank shall be fitted with drip trays. In decked vessels with machinery space, filling pipes and airing pipes shall be carried through the deck and into open air.

(3) If extra fuel or other flammable liquids cannot be placed on open deck, they shall be stored in suitable containers in a well-ventilated room/locker with a door communicating only with open deck and without electrical or other sources of ignition.

Section 21. *Materials in pipelines, etc.*

(1) Seawater pipes, bilge pipes, pipes conveying oil and other pipelines required for the safety of the ship shall be made of non-combustible material. Short, flexible pipe connections made of a material which is not easily rendered ineffective by heat, may be accepted on:

- a. seawater pipes;
- b. short, flexible pipe connections on pipes conveying oil, when necessitated by vibrations.

(2) Where failure of the material due to fire may lead to flooding, scuppers, sanitary discharges or other outlets which are close to the waterline shall be made of oil-resistant and reinforced materials which are not easily damaged by heat.

Section 22. Machinery and piping systems

(1) Vessels constructed after 1 January 1992 shall satisfy the requirements of Nordic Boat Standard (1990)

- a. C6 on bilge systems;
- b. C9 on oil fuel systems;
- c. C8 on engine installations; and
- d. C7 and C10 on rudder and propeller arrangements.

(2) Vessels constructed before 1 January 1992 shall as far as possible satisfy the requirements of Nordic Boat Standard (1990 chapter C6 on bilge systems).

Section 23. Electrical installations

(1) Vessels of 6 to 15 metres in overall length constructed after 1 January 1992 with electrical installations with voltages of up to 50 V shall satisfy the requirements of Nordic Boat Standard (1990) C11 on electrical installations.

(2) Vessels of 6 to 15 metres in overall length constructed before 1 January 1992 with electrical installations with voltages of up to 50 V shall be in compliance with the rules in force at the time of construction.

(3) Vessels of 6 to 15 metres in overall length constructed between 1 January 1992 and 2002 with electrical installations with voltages of more than 50 V shall satisfy the requirements laid down in the now repealed Regulations of 1 March 1990 No. 125 for electrical installations - Maritime installations.

(4) Vessels of 6 to 15 metres in overall length constructed after 1 January 2002 with electrical installations with voltages of more than 50 V shall satisfy the requirements laid down in Regulations of 4 December 2001 No. 1450 concerning maritime electrical installations, laid down by the Norwegian Directorate for Civil Protection.

Section 24. Emergency source of power and emergency lighting, etc.

(1) Vessels of 10.67 to 15 metres in overall length constructed after 1 January 1992 shall have an emergency source of power providing satisfactory lighting for at least 2 hours to:

- a. lighting in areas with life-saving appliances and launching arrangements;
- b. lighting in alleyways, stairways and exits to the life-saving appliances and of the sea where the life-saving appliances are launched;
- c. necessary navigation lights; and
- d. required alarm system.

(2) The emergency power shall be provided by one of the following two sources:

- a. an accumulator battery capable of carrying the load pursuant to the first paragraph without recharging or suffering an excessive voltage drop, and which is automatically connected to the emergency switchboard when the main power fails; or
- b. a generator driven by a suitable type of power machinery with an independent supply of fuel, appropriate starting arrangements and driven by fuel having a flashpoint of not less than 43°C (110°F).

(3) The entire installation shall be capable of operating even when the vessel is listed to 22.5 degrees or when the trim of the vessel is 10 degrees.

(4) Switchboards for main power and emergency power shall be clearly marked and be placed, as far as practicable, so that they cannot be exposed to water or fire. The emergency source of power shall if possible be placed above deck. If the emergency source of power is placed in the machinery space, it shall be placed above the floor and in a well-ventilated place.

(5) The emergency source of power and the emergency lighting on vessels constructed before 1 January 1992 shall be in accordance with the rules in force at the time of construction.

Section 25. Equivalents

Vessels constructed pursuant to Nordic Boat Standard (1990) are considered to satisfy the requirements of sections 18, 19 and 20.

4. Stability and freeboard

Section 26. *Stability calculations*

- (1) For new vessels of 6 to 15 metres in overall length, the stability calculations shall be carried out in accordance with these Regulations. Alternatively, stability calculations may be carried out in accordance with the Regulations of 13 June 2000 No. 660 on the construction, equipment and operation of fishing vessels of 15 metres in length and over. These provisions may also be used for existing vessels.
- (2) For vessels of 6 to 10.67 metres in overall length constructed between 1 January 1992 and 1 January 2015 the stability calculations shall be prepared in accordance with:
 - a. Nordic Boat Standard (1990); or
 - b. Regulations of 13 June 2000 No. 660 on the construction, operation, equipment and surveys of fishing vessels of 15 m in overall length (LOA) and over; or
 - c. Regulations of 15 October 1991 No. 712 on the constructions of vessels of 15 metres in overall length (LOA) and over;
 - d. Regulations mentioned in the first paragraph.
- (3) For vessels of 8 to 10.67 metres in overall length constructed between 1 March 1983 and 1 January 1992 the stability calculations shall be prepared in accordance with:
 - a. Nordic Boat Standard (1990);
 - b. Regulations of 7 January 1983 No. 12 on the construction of fishing vessels; or
 - c. Regulations mentioned in the first and second paragraphs.
- (4) For vessels of 8 to 10.67 metres in overall length constructed before 1 March 1983 the stability calculations shall be prepared in accordance with:
 - a. Nordic Boat Standard (1990);
 - b. Regulations of 2 October 1968 No. 8943 on the construction of fishing vessels; or
 - c. Regulations mentioned in the first to third paragraphs.
- (5) Existing vessels of 10.67 to 15 metres in overall length shall have stability calculations in accordance with the regulations in force at the time of:
 - a. construction;
 - b. a later major conversion; or
 - c. newer Regulations.
- (6) Existing vessels of 6 to 15 metres in overall length, which undergo modifications that affect buoyancy volumes or cause the draught to increase, shall satisfy the stability requirements for new vessels.

0 Amended by Regulation of 6 December 2021 No. 3415 (in force on 1 January 2022).

Section 27. *Stability documentation and inclining test*

- (1) Hull geometry, hydrostatics, cross curves and supporting documentation shall be prepared by means of software listed on the Norwegian Maritime Authority's list of approved stability calculation programmes. Loading conditions, hydrostatics and cross curves shall be calculated under free trim.
- (2) When construction and equipping is completed, the vessel shall be subjected to an inclining test pursuant to the procedure in Appendices 6 and 7. The actual displacement and position of the centre of gravity shall be determined for the lightship condition.
- (3) If alterations are made to a vessel of 8 to 15 metres in overall length which affect the vessel's stability, revised stability calculations, if applicable based on lightship data from a new inclining test, shall be prepared and presented to an approved company for inspection.

(4) Stability and lightship data for vessels of 8 metres or more in overall length shall be inspected by an approved company and found to satisfy the requirements of this chapter.

0 Amended by Regulations of 6 December 2021 No. 3415 (in force on 1 January 2022), 27 March 2023 No. 459.

Section 28. *Stability for closed vessels*

(1) Vessels shall be so designed and constructed that the requirements of this chapter will be satisfied in the operating conditions referred to in the second to sixth paragraphs.

(2) For closed vessels, cf. Nordic Boat Standard (1990) C2, GZ curves (curves showing righting levers) shall be corrected for trim and for the free surface effects of fuel oil tanks, fresh water tanks and any other tanks with loading conditions corresponding to:

- a. departure for the fishing ground with 100 per cent fuel, fresh water, provisions, fishing gear and otherwise fully equipped;
- b. arrival at port without catch with 10 per cent fuel, fresh water and provisions, and fully equipped; and
- c. maximum permissible draught, showing departure from the fishing ground with full holds, minimum 50 per cent fuel, fresh water and provisions, and fully equipped. The specific gravity used for the cargo shall not be higher than for seawater. Catch on deck, if appropriate to the mode of operation, shall be included. Water ballast tanks, if any, shall be empty;
- d. arrival at port with full holds and maximum 10 per cent fuel, fresh water and provisions, and fully equipped, and with the same amount of cargo as in subparagraph c). Catch on deck, if appropriate to the mode of operation, shall be included. Water ballast tanks, if any, shall be empty;
- e. loading conditions representing the least favourable stability steps during filling/draining of the cargo holds and water ballast tanks, if any.

(3) If appropriate to the mode of operation, loading conditions on the fishing ground with maximum catch on deck, an empty hold and 10-50 per cent fuel, fresh water and provisions, and fully equipped, shall be prepared. The condition shall be shown with the smallest applicable amount of fuel, fresh water and provisions.

(4) If the vessel is operating in loading conditions which are less favourable than conditions as referred to in the second and third paragraphs, calculations shall also be prepared for such loading conditions.

(5) For conditions as referred to in the first to third paragraphs, the calculations shall also take into account the following:

- a. the weight of seawater in fishing gear on deck;
- b. the weight of ice accretion;
- c. in the fully loaded conditions, the cargo shall be homogeneously distributed among all holds, hatch coamings and trunks, if any. Homogeneously distributed cargo means that a volumetric centre of gravity and invariable density shall be used for all spaces available for the carriage of cargo;
- d. fully loaded conditions with specific gravity for the cargo as for seawater shall be shown with free surface effects if the specific gravity of the cargo in the homogeneous conditions (for vessels carrying liquid cargo, i.e. fish in bulk or fish in ice/water) is less than for seawater;
- e. allowance for the free surface effects of liquids in tanks and, if applicable, cargoes where a free surface effect may occur;
- f. ballast shall be located and secured so that it cannot shift. Permanent ballast shall not be removed or moved from the vessel. Liquid ballast may be accepted as permanent ballast, provided that it is stored in completely full tanks and that these tanks are not connected to the vessel's pumping systems. When liquid ballast is used as permanent ballast, detailed information thereof shall be included in the vessel instructions and the stability documentation;
- g. water ballast tanks shall in principle be kept completely full or completely empty. Water ballast (seawater) may be included in ballast conditions, if it is used either in tanks especially intended for this purpose or in other tanks which are also designed to carry water ballast, and which are connected to the vessel's pumping system. If the amount of water ballast is different in the departure condition and the arrival condition, intermediate conditions shall be calculated indicating when water ballast must be replenished or drained. The calculations shall in that case indicate the stability situation immediately prior to replenishing or after drainage of water ballast;
- h. ice, packaging, salt, etc. shall only be included if it has an adverse effect on the stability.

Section 29. Stability criteria

- (1) The following minimum stability criteria shall be met in all loading conditions:
 - a. The area under the righting lever curve (GZ curve) shall not be less than 0.055 m-rad from 0 to 30 degrees angle of heel and not less than 0.090 m-rad from 0 to 40 degrees or the angle of flooding θ_f if this angle is less than 40 degrees. Additionally, the area under the curve between the angles of heel of 30 degrees and 40 degrees or between 30 degrees and θ_f if this angle is less than 40 degrees, shall not be less than 0.030 m-rad. The GZ curve shall be calculated without initial trim. In connection with the stability criteria above and section 32 third paragraph, hatches which periodically need to be kept open during fishing shall in addition be considered openings of flooding despite their being arranged so as to be capable of being rapidly closed weathertight.
 - b. The righting lever shall be at least 200 millimetres at an angle of heel equal to or greater than 30 degrees.
 - c. The maximum righting lever GZ_{max} shall occur at an angle of heel preferably exceeding 30 degrees but not less than 25 degrees.
 - d. The initial metacentric height (GM) shall not be less than 350 millimetres.
 - e. for vessels operating in trade area In-shore fishing or greater trade area, the righting lever (GZ) for angles of heel between 40 and 65 degrees shall nowhere be less than 100 millimetres, and positive up to 80 degrees, not considering flooding through hatches, doors, bilge valves, etc. which must remain open during operation, but which can rapidly be closed weathertight.
- (2) As an alternative to the stability criteria of the first paragraph, the provisions of Nordic Boat Standard (1990) chapters C3 and C30 may be applied. Vessels operating in trade area Fjord fishing do not need to comply with the Nordic Boat Standard chapter C30 paragraph 3.2.
- (3) The vessel's metacentric height (GM) in the lightship condition shall be positive irrespective of choice of stability criteria.

0 Amended by Regulation of 6 December 2021 No. 3415 (in force on 1 January 2022).

Section 30. Bow height

Vessels constructed after 1 January 1992 shall have a bow height of at least $43 \times \text{LOA} + 310$ [millimetres] measured vertically at the stem from the loaded waterline to the exposed deck. Bow height requirements laid down in the Nordic Boat Standard (1990) may as an alternative be applied. Where the bow height is obtained by a superstructure arrangement, such superstructure shall be closed and extend from the stem to a point at least $0.10 \cdot \text{LOA}$ abaft the forwardmost part of the hull. The requirement for bow height shall be satisfied for 0 trim and for loading conditions with forward trim.

Section 31. Stability and freeboard for open vessels

Open vessels shall satisfy the requirements of Nordic Boat Standard (1990) C3.

Section 32. Water on decks and in open spaces

- (1) Vessels of 6 to 15 metres in overall length constructed after 1 January 1992 and vessels of 6 to 15 metres in overall length which have undergone a major conversion after this date shall satisfy the requirements of the second to fifth paragraphs.
- (2) If water can accumulate on weather-exposed decks, the stability calculations shall take into account the effects of such water accumulation. This applies e.g. to arrangements with open foredeck, open deckhouses with side walls against the ship's side, separate side walls in the ship's side or similar erections on deck.
- (3) If hatches and similar openings periodically have to remain open during operation, calculations shall be made of the vessel's stability after the flooding of the spaces that may be flooded, if the angle of flooding θ_f for the opening concerned is less than 30 degrees.
- (4) Calculations with water on deck shall be carried out in accordance with Appendix 9.
- (5) If openings are arranged in bulwarks above ordinary rail height, and they constitute at least 60 per cent of the overall area above one metre rail height, the requirement for calculation of water on deck does not apply. Such openings must not be covered in a way that prevents effective drainage in the event of flooding.

Section 33. Icing allowance

(1) For vessels of 6 to 15 metres in overall length which are constructed or have undergone a major conversion after 1 January 1992 and which are operating in greater trade area than In-shore fishing in the period from 1 November to 30 May, the following allowance shall be made in the stability calculations:

- a. 30 kilogrammes per square metre on exposed weather decks, gangways, forward bulkheads of superstructures and deckhouses;
- b. 7.5 kilogrammes per square metre for projected lateral area of each side of the vessel above the water plane;
- c. the projected lateral area of discontinuous surfaces of rail, spars (except masts) rigging of vessels having no sails and projected lateral area of other small objects shall be computed by increasing the total projected area of continuous surfaces by 5 per cent and the static moments of this area by 10 per cent.

(2) For vessels without icing allowance calculations, the trade area is limited to In-shore fishing in the period from 1 November until 30 April. (3) Vessels intended for operation in areas where ice accretion is known to occur shall be equipped with appropriate means for removing ice.

0 Amended by Regulation of 6 December 2021 No. 3415 (in force on 1 January 2022).

Section 34. Stability information

(1) On vessels with stability calculations, the master shall have access to all stability information.

(2) A stability poster shall be posted in vessels with a wheelhouse. The poster shall at least include the following information:

- a. type of cargo and maximum amount of cargo in cargo holds and on decks pursuant to section 28 second paragraph subparagraphs b, d and e;
- b. weight and placement of fishing gear;
- c. other limitations resulting from water ballast or anti-rolling tank.

(3) Stability information for vessels with a requirement for vessel instructions shall be verified by an approved company.

0 Amended by Regulation of 6 December 2021 No. 3415 (in force on 1 January 2022).

Section 35. Freeboard

(1) Freeboards determined from the surface of the working deck at side amidships shall correspond to the maximum permissible operating draught and shall not be less than zero.

(2) For vessels constructed after 1 January 1992, the freeboard shall be in accordance with Nordic Boat Standard (1990) C3.

(3) The freeboard amidships shall be stated in the vessel instructions.

(4) Draught marks shall be indicated on both sides of the vessel in accordance with Nordic Boat Standard (1990) C2.

(5) For vessels with a superstructure covering the entire breadth of the vessel, the minimum freeboard in accordance with Nordic Boat Standard (1990) C3 may be measured from the lowest part of the exposed deck outside of the closed superstructure. Freeboard to the upper edge of the draught mark amidships, cf. Nordic Boat Standard (1990) C2, may be corrected in accordance with this, even if the deck, if any, inside such closed superstructure is closer than 200 millimetres to the loaded waterline. Measurements of freeboard to the loaded waterline shall take into account the estimated trim in accordance with Nordic Boat Standard (1990).

0 Amended by Regulation of 6 December 2021 No. 3415 (in force on 1 January 2022).

5. Life-saving appliances and arrangements

Section 36. *Lifejackets*

- (1) Vessels shall have a type-approved lifejacket for every person on board.
- (2) Lifejackets shall be kept readily available in the vicinity of the life-saving appliances in a clearly marked place. Information about the location, treatment and use of the lifejackets shall be posted on board.

Section 37. *Immersion suits*

- (1) Decked vessels and open vessels with wheelhouse shall have a type-approved immersion suit with thermal properties for every person on board. Immersion suits procured after 1 July 2014 shall also satisfy the requirements for buoyancy and stability for lifejackets in the International Life-Saving Appliance Code (LSA Code).
- (2) Immersion suits shall be fitted with:
 - a. a loop/strap or similar device with an appropriate hooking and holding arrangement for use with hoisting tackle.

The suit and loop/strap shall, when a person is wearing the suit, not be damaged when exposed to a load of at least 300 kg;
 - b. a signal whistle which is secured to the suit by a lanyard; and
 - c. a light satisfying the requirements of the LSA Code for lifejacket lights.
- (3) Loop/strap, grabline, whistle, lights, etc. shall be so secured as not to impair the properties of the suit or interfere with the use of the suit.
- (4) Lifejackets and immersion suits shall be marked in such a way that they can be traced back to the vessel where the equipment is used.
- (5) Immersion suits which are 8 years old or more, shall be pressure-tested/tested for tightness at an approved servicing station. The suit shall thereafter be pressure-tested/tested for tightness at intervals not exceeding 36 months, but not more often than recommended by the manufacturer.
- (6) Persons not able to use a standard immersion suit shall have an immersion suit of adapted size on board, and the immersion suit shall be clearly marked.
- (7) The immersion suits shall be kept in a suitable and clearly marked place in or in the vicinity of the wheelhouse. For vessels with more than one immersion suit per person, the additional immersion suits shall be available in an easily accessible place. Posters or placards with information about the placement, treatment and use of immersion suits shall be posted on board.

Section 38. *Liferaft*

- (1) Decked vessels of more than 6 metres in overall length shall have a type-approved liferaft with capacity for the total number of persons on board.
- (2) Vessels with a maximum of three persons on board may as an alternative to a type-approved liferaft use a liferaft intended for at least four persons and manufactured in accordance with ISO 9650-1 (Group A), provided that the raft is placed a maximum of six metres above the waterline in the least favourable loading condition.
- (3) Vessels with a liferaft for recreational craft for four people shall replace these with rafts pursuant to the first or second paragraph by:
 - a. 1 July 2015 for vessels operating in trade area In-shore fishing;
 - b. 1 July 2016 for vessels operating in trade area Fjord fishing.
- (4) Inflatable liferafts shall be inspected by an approved service station for inflatable liferafts at least every 24 months, however, not exceeding the limit for the next inspection set out in the liferaft certificate. The inspection shall be carried out in line with the manufacturer's recommendations and approval criteria.

(5) Liferrafts shall be ready for use and so placed as to permit them to float free from their stowage, inflate and break free from the vessel in the event of its sinking. Lashings, if used, shall have a hydrostatic release system. Equipment for hydrostatic release of rafts with a capacity to accommodate six persons or more shall be type-approved.

(6) Posters or placards with information about the location, treatment and use of the rafts shall be posted on board.

(7) Auxiliary vessels need not have a liferaft if the crew is only on board during fishing activities and are otherwise on board the main vessel.

0 Amended by Regulation of 6 December 2021 No. 3415 (in force on 1 January 2022).

Section 39. Placement of life-saving appliances

(1) The life-saving appliances shall as far as possible be equally distributed on each side of the vessel, and be placed so that there is sufficient space for preparation, operation and embarkation.

(2) The life-saving appliances shall be placed so that they do not protrude from the vessel's sides, at a safe distance from the waterline and propellers, and so that they as far as practicable can be launched with vertical shipside.

(3) It shall be possible for one person to launch the life-saving appliances by himself.

Section 40. Alarm equipment

Vessels shall have suitable means for alerting everyone on board about meeting at the life-saving appliances and about when the vessel should be abandoned.

Section 41. Boarding of life-saving appliances

Vessels on which the height from the water plane to where the life-saving appliances are to be boarded is more than two metres in the smallest draught in ballast, shall have a ladder or other approved equipment providing access to the life-saving appliances when they are in the water.

Section 42. Precautions for keeping life-saving appliances and other rescue equipment ready for use

All life-saving appliances and other rescue equipment shall be in good condition and ready for immediate use, also in unfavourable conditions of list or trim.

Section 43. Lifebuoys

(1) There shall at least be one lifebuoy for every three persons on board.

(2) At least half of the lifebuoys shall have type-approved buoy lights and all the lifebuoys shall:

- a. be marked with the vessel's name and port of registry; and
- b. be placed conspicuously and readily available, so that they can be released quickly and easily.

(3) Vessels of less than 10.67 in overall length shall have at least one lifebuoy with a buoyant lifeline of at least 30 metres.

(4) Vessels of 10.67 to 15 metres in overall length shall have at least two lifebuoys. There shall be one lifebuoy with a buoyant lifeline of at least 30 metres on each side of the vessel.

0 Amended by Regulation of 6 December 2021 No. 3415 (in force on 1 January 2022).

Section 44. Distress signal equipment and pyrotechnical equipment

(1) Vessels shall be equipped with means for making effective distress signals by day and by night. Vessels shall have at least two smoke signals. In addition, vessels shall have the following equipment:

- a. three rocket parachute flares and three red hand flares in trade area Fjord fishing;
- b. three rocket parachute flares and three red hand flares in trade area In-shore fishing;
- c. six rocket parachute flares and four red hand flares in trade area Bank fishing I;
- d. six rocket parachute flares and four red hand flares in trade area Bank fishing II.

(2) Distress signal equipment shall be type-approved, clearly marked and kept in a suitable casing in an easily accessible place. Distress signal equipment shall be replaced at the latest within the indicated use-by date or three years from date of manufacture if use-by date is not indicated.

Section 45. Alarm system, muster list and drills

- (1) New vessels which are decked or open with wheelhouse, with a crew of two or more, shall have an alarm system to alert the persons on board in the event of danger. The alarm system may be connected to the fire alarm system required pursuant to section 16. The alarm shall in addition be capable of being triggered manually. The alarm shall continue to sound until it is manually turned off.
- (2) On board existing vessels alerting may be done with signals from the vessel's whistle or siren.
- (3) Vessels with a crew of two or more shall be equipped with clear instructions (muster list) for each member of the crew.
- (4) The muster list shall be posted and made known to the persons on board, and shall include:
- a detailed description of the alarm system, along with the measures to be taken by the crew when the alarm is sounded and the order in which the crew shall leave the vessel;
 - information about the location of life-saving equipment, life-saving appliances, fire-fighting equipment, pyrotechnical equipment, closing of doors, valves, hatches, etc., the meaning of the alarm signals, and the precautionary measures to be taken;
 - which persons are assigned to ensure that the life-saving and fire appliances are maintained, in good condition and are ready for immediate use; and
 - specification of substitutes for key personnel who may have become unfit for service, taking into account that the different emergencies may call for different actions.
- (5) The master shall change the muster list or create a new muster list if there are changes in the crew making it necessary to change the muster list.
- (6) Abandon ship drills and fire drills shall take place at least once every three months and when more than 1/3 of the crew has been replaced. Drills shall comply with the muster list, and the entire crew shall participate in the drills.

Section 46. Life-saving appliances not complying with the requirements of these Regulations are not permitted on board.

6. Safety measures

Section 47. Trade area restrictions

- (1) Vessels of less than 6 metres in overall length or open vessels irrespective of size (as defined in Nordic Boat Standard (1990)) may not be used in trade areas greater than Fjord fishing.
- (2) Decked vessels of 6 to 8 metres in overall length may not be used in trade areas greater than Bank fishing I.
- (3) Decked vessels of 8 to 10.67 metres in overall length may not be certified for trade areas greater than Bank fishing I. In the period from 1 May to 31 October, vessels of 8 to 10.67 metres in overall length may be certified for Bank Fishing II, limited to 100 nautical miles from the base line.
- (4) Decked vessels of 10.67 to 15 metres in overall length may not be used in trade areas greater than Bank fishing II.

0 Amended by Regulation of 6 December 2021 No. 3415 (in force on 1 January 2022).

Section 48. Fixed and portable means of access on board

- (1) Fixed and portable means of access shall be properly maintained.
- (2) Where there is a risk of someone falling over board and down into spaces, tanks and similar, lifelines, handrails or barriers shall be provided.
- (3) Corridors, means of escape, deckhouse, all alleyways, workspaces and accommodation shall have handrails/grab rails, guard rails or similar equipment ensuring safe passage and stay on board.

Section 49. Means of access for safe embarkation and disembarkation

Vessels shall have means of access on board, so that embarkation and disembarkation may be effected in a safe and proper manner.

Section 50. Means of closure - hatches and doors

- (1) All external openings shall be capable of being closed weathertight so as to prevent water from entering the vessel. Hatches and doors shall have gaskets and toggles.
- (2) Hatches and watertight, weathertight and spraytight doors shall be in working order and be capable of closing without delay in a simple manner. The doors shall be clearly marked by notices indicating that the doors shall be kept closed while the vessel is at sea.
- (3) Hatches/doors on exposed decks to cargo holds and other spaces/tanks below deck shall be closed and battened down when the vessel is at sea. When cargo hold hatches and doors, if applicable, have to be kept open in connection with the operation of the vessel, including taking on board catch, these shall be capable of being closed immediately.
- (4) Hatch covers shall be secured when in open position.
- (5) Hatches in decks, manholes and similar, which are in open position, shall be adequately lighted and effectively fenced off.

Section 51. Hatches to covered working and production decks

- (1) Hatches to covered working deck or production deck, which are in open position, shall be capable of being closed without delay if there is a danger of flooding of the working deck. Side hatches shall be capable of being closed in 15 seconds.
- (2) Hatches shall be clearly marked by notices indicating that the hatches shall be kept closed when not in use during fishing.
- (3) The construction and arrangement of hatches to covered working and production decks, monitoring as well as audible and visual alarms etc., in connection with the use of hatch and manoeuvring and closing arrangements shall be in accordance with Regulations of 13 June No. 660 on the construction, operation, equipment and surveys of fishing vessels of 15 m in overall length (LOA) and over, section 2-16 second and third paragraphs.

Section 52. Drainage of covered working decks

Bilge flaps for drainage of covered working decks shall during normal operation be kept closed when the vessel is at sea.

Section 53. Carriage of deck cargo

Deck cargo shall be secured against shifting, and shall be capable of being released easily if necessary.

Section 54. Loading, drainage of open deck

- (1) Vessels shall be loaded so as to have adequate freeboard under all conditions, due consideration being given to the construction, stability, waters and season, so that the safety of vessel and crew is ensured. The permitted freeboard in accordance with the load lines on the vessel's sides shall be complied with at all times. Under no circumstances shall the vessel be loaded so that trim, negative sheer, etc. causes submersion of any part of the exposed freeboard deck in water.
- (2) Unobstructed outlet shall be provided for water from open decks through freeing ports or through open railings.

Section 55. Inspection to ascertain gas hazard etc.

- (1) No person may enter tanks, cargo holds, narrow enclosed spaces, tunnels or other spaces presenting a risk of gas or insufficient oxygen without wearing approved or accepted breathing protection, or before the necessary

checks have been made to ascertain that the air in those spaces is safe. Measurements shall be taken at various heights and repeated measurements shall be taken if necessary.

(2) Spaces as referred to in the first paragraph shall be thoroughly ventilated before work is started in them. Larger spaces shall be provided with continuous mechanical ventilation as long as work is in progress.

(3) While inspection/work is in progress in tanks/spaces the oxygen content and any gas concentration shall be measured at short intervals. The work/inspection shall be supervised by two persons, one of whom shall have easy access to a self-contained breathing apparatus and be trained in its use.

Section 56. *Marking of tanks, spaces, etc. and warning signs*

(1) All doors, hatches, manhole covers, etc. providing access to gas-hazardous spaces or spaces presenting a risk of insufficient oxygen shall be clearly marked giving warning of the hazard of gas poisoning or lack of oxygen to which a person may be exposed. In places where the marking can easily be damaged or dirtied, the actual hatch, cover or similar shall also be painted in the same colour as the signs. The colour of the warning signs and adhesive notes shall be in accordance with Norwegian Standard NS 6033 or NS 4210, and have Norwegian text clearly expressing the following:

FARE OKSYGENMANGEL (Symbol)	DANGER LACK OF OXYGEN
FARE GIFTIG GASS (Symbol)	DANGER POISON GAS
FARE EKSPLOSIV ATMOSFÆRE (Symbol)	DANGER EXPLOSIVE ATMOSPHERE

(2) In vessels calling at ports outside Scandinavia, Iceland and Greenland, the warning signs as referred to in the first paragraph shall also be provided with English text.

Section 57. *Signs and notices*

(1) The text of signs and notices shall always be clearly legible, and shall if necessary be illuminated. The text shall be in Norwegian, if necessary also in other languages.

(2) Warning signs shall have lettering at least 20 mm high and prohibition signs shall have lettering at least 30 mm high. Unless otherwise provided, the colours shall be in accordance with Norwegian Standard NS 6033 or NS 4210.

Section 58. *Storage of fuel*

If extra fuel cannot be placed on open deck it shall be stored in suitable containers in a separate, easily accessible and well ventilated room/locker with a door communicating only with open deck. Bulkheads and door to the room/locker shall have fire insulation equivalent to A-60.

Section 59. *Warning sign at radar scanners*

The radar apparatus shall be switched off during work in the radar mast, and a clearly visible sign shall be displayed at every radar apparatus with the following warning: "Work in progress in the radar mast".

Section 60. *Radar reflector*

Vessels with superstructures not capable of reflecting radar as well as steel shall be provided with a radar reflector.

Section 61. *Retro-reflective means*

(1) Vessels shall be fitted with permanent retro-reflective means clearly visible from both the sea and the air, with a width of at least 50 mm and a length of at least 300 mm.

(2) There shall be at least four retro-reflective means on each side of the vessel. The means shall be placed as high as possible on the hull in a broken line with a distance of approx. 500 mm. In addition, six retro-reflective means which are clearly visible from the air shall be installed

Section 62. Anti-skid surfaces on deck

In work areas and normal alleyways on board, including stairways, the surfaces underfoot shall provide a good foothold, and shall if necessary be fitted with additional anti-skid devices.

Section 63. Ladders

A fixed ladder with handrails shall be fitted on the aft part of the vessel. The bottom step of the ladder shall reach at least 300 mm below the waterline.

0 Amended by Regulation of 27 March 2023 No. 459.

7. Radio

Section 64. Scope of application

This chapter applies to decked vessels and open boats with wheelhouse.

Section 65. Documentation which shall be available on board

The following documentation pertaining to radio equipment shall be available on board:

	<i>Fjord fishing and In-shore fishing</i>	<i>Bank fishing I and Bank fishing II</i>
IAMSAR volume III	X	X
Instruction manuals for each piece of radio equipment	X	X
Channel plan and frequency tables for the trade area in question	X	X
Permission for use of frequencies (licence)	X	X
Radio records. The deck log book may be used as radio records	X	X
GMDSS map		X
GMDSS Operating Guidance for Masters of Ships in Distress Situations		X
ITU's Manual for use by the Maritime Mobile and Maritime Mobile-Satellite Services		X
GMDSS emergency procedures (shall be posted at the radio station)	X	X
Drawings showing the radio arrangement (antenna drawings, drawings of the location of the radio equipment in the wheelhouse and wiring diagram)	X	X

Section 66. Safety radio certificate

- (1) Vessels shall have fishing vessel radiotelephony safety certificate.
- (2) Fishing vessel radiotelephony safety certificates are issued for a period of:
 - a. 60 months for trade area Bank fishing I or lesser;
 - b. 30 months for trade area Bank fishing II.
- (3) Fishing vessel radiotelephony safety certificates are issued by an approved radio inspection company, based on an inspection. Such inspection may be carried out within two months prior to the expiry of the period of validity of the existing safety certificate, without the date of the next inspection being changed.

Section 67. Requirements for approval

- (1) Equipment required pursuant to this chapter shall be CE marked in accordance with Regulations of 15 April 2016 No. 377 related to EEA requirements to radio equipment or shall satisfy the requirements of Regulations of 30 August 2016 No. 1042 on marine equipment.
- (2) Equipment installed before 1 January 2014 may be exempted from requirements for type-approval, provided that it is equivalent to equipment complying with the performance standards and that it satisfies the requirements for the equipment which were applicable at the time of instalment.
- (3) Radio equipment not required pursuant to these Regulations, but which is voluntarily installed on board, shall satisfy either the requirements of this section or the requirements of Directive 2004/71/EC.

0 Amended by Regulations of 20 December 2017 No. 2379 (in force on 1 January 2018), 6 December 2021 No. 3415 (in force on 1 January 2022).

Section 68. Functional requirements and equipment requirements

- (1) Vessels shall be capable of transmitting a distress signal using at least two separate and independent radio systems (primary and secondary alarm relaying source). Duplicated radio equipment, manual satellite EPIRB and float-free satellite EPIRB may be used as a secondary alarm relaying source. Free-float satellite EPIRB and manual satellite EPIRB shall be fitted with an integrated position indicator.
- (2) The requirement for a secondary alarm relaying source does not apply to vessels with vessel instructions for trade area Fjord fishing.
- (3) Vessels shall be fitted with radio installations as referred to in the table below.

<i>Sea areas →</i> <i>Trade areas →</i> <i>Radio equipment and radio life-saving appliances</i> ↓	A1			A2	Notes
	<i>Fjord fishing</i>	<i>In-shore fishing</i>	<i>Greater than In-shore fishing</i>		
VHF radio installation at least capable of transmitting and receiving DSC on channel 70 and radiotelephony on channels 6, 13 and 16. The watch receiver may be a separate unit.	X	X	X	X	1
Radar transponder (radar SART), or AIS transponder (AIS SART)	-	X	X	X	6
NAVTEX receiver 518/490 kHz	X	X	X	X	4
Float-free satellite EPIRB (satellite-emergency position-indicating radio beacon) which shall be so placed that it with the utmost likelihood will float up to the surface and transmit a distress signal if the vessel should sink.	-	X	X	X	2, 5
MF-DSC at least capable of transmitting and receiving DSC on the frequency 2187.5 kHz and telephony on the frequency 2182 kHz. The watch receiver may be a separate unit.	-	-	-	X	1
Two-way VHF radiotelephone apparatuses (hand-held VHF)	-	X	X	X	3

Notes:

Note 1	All equipment shall be turned on when the vessel is underway, and vessels shall maintain a listening watch on VHF channel 16.
Note 2	Float-free satellite EPIRBs shall be maintained by an approved shore-based company at least every five years.
Note 3	On vessels in trade areas Bank fishing I and Bank fishing II with more than one (1) survival craft, the number of hand-held VHF's shall be at least 2.
Note 4	A NAVTEX receiver is not required in sea area A1 if the vessel is capable of otherwise maintaining the same safety function by obtaining relevant weather and navigational warnings through the VHF coast radio, public electronic systems or other public broadcasts.
Note 5	A float-free satellite EPIRB may be replaced by a manual satellite EPIRB on vessels with a buoyancy causing it to not sink deep enough for a float-free EPIRB to be released, or on vessels having a type of superstructure which makes it dangerous for a person to retrieve the float-free EPIRB in order to activate it manually and bring it along to a survival craft. A manual satellite EPIRB shall be placed readily available, so that it can readily be activated and brought into a survival craft.
Note 6	1. Vessels operating in or having vessel instructions for trade area In-shore fishing or Bank fishing I, shall be fitted with one transponder. 2. Vessels operating in or having vessel instructions for trade area Bank fishing II, shall be fitted with two transponders.

0 Amended by Regulations of 4 May 2015 No. 445 (in force on 6 May 2015), 6 December 2021 No. 3415 (in force on 1 January 2022), 27 March 2023 No. 459.

Section 69. Installation and placement of equipment

- (1) Radio installations shall be installed so that they are readily accessible for inspection and maintenance purposes and so that they are not exposed to dangerous effects from humidity, extreme temperatures or other environmental conditions.
- (2) Radio installations shall be installed so that they are not affected by mechanical, electrical or electromagnetic interference and so that the actual installations cannot cause such interference themselves.
- (3) Radio installations shall be marked with call sign and other GMDSS identities and codes, such as MMSI, which are necessary in order to identify the installation.
- (4) Control of the VHF radiotelephone channels required for navigational safety, shall be immediately available in the wheelhouse convenient to the conning position. If the conning position periodically is not in the immediate vicinity of the wheelhouse, it shall be possible to conduct radio communication from such manoeuvring positions. Portable VHF equipment may be used to meet the latter provision.
- (5) The float-free satellite EPIRB shall be so installed that it with the utmost likelihood will float freely up to the surface without risk of being caught on obstacles such as railing, superstructure, etc., if the ship should sink.
- (6) The float-free and manual satellite EPIRB shall be so installed that it can be:
 - a. activated manually; and
 - b. carried by one person into a survival craft without endangering that person.
- (7) SART shall be installed in the wheelhouse. If the ship is required to carry two SARTs, they shall be placed on each side of the vessel, preferably by the exit doors of the wheelhouse, so that they may easily be brought along into a survival craft.
- (8) The antennas for the radio installation shall be so placed and installed that optimal efficiency is achieved, at the same time as negative electromagnetic influences (EMC) from radio equipment and other electronic equipment, especially navigation equipment, is avoided.
- (9) All exterior cables and couplings shall be kept clean from salt, soot and other pollutants, be regularly inspected and be replaced as needed.

Section 70. Sources of electrical power

- (1) The radio installation shall be connected to the vessel's main source of power, as well as an reserve source of power.
- (2) The reserve source of power shall have sufficient capacity for operating the equipment listed in the fifth paragraph for at least six hours. If the vessel is equipped with an emergency generator with an operational capacity of 18 hours or more, the capacity of the reserve source of power shall be one hour.
- (3) It shall be possible to recharge the reserve source of power from the vessel's main source of power, as well as from the emergency generator, if applicable.
- (4) The reserve source of power shall be placed in protected surroundings above the uppermost continuous deck, preferable in a well-ventilated battery room or battery casing. The placement shall provide safe and simple access for maintenance and inspection purposes, be in accordance with the manufacturer's instructions, and otherwise be such that the source of power can function even in extraordinary conditions.
- (5) The reserve source of power shall provide power to the operation of the vessel's VHF radio installation as well as:
 - a. the MF radio installation in sea area A2;
 - b. navigation receiver (may be connected to the vessel's reserve source of power); and
 - c. lighting for the radio installation.
- (6) The reserve source of power must in addition be:
 - a. capable of automatically recharging to minimum capacity within 10 hours, if the reserve source of power is rechargeable batteries;
 - b. independent of the vessel's propulsion machinery;
 - c. inspected weekly by the vessel's radio operator and in connection with radio tests, cf. section 73 first paragraph subparagraph e; and
 - d. maintained in accordance with the manufacturer's instructions.
- (7) The batteries shall be replaced at the first sign of reduced capacity.

Section 71. Radio watch

- (1) All vessels not safely moored in port shall maintain a continuous radio watch on the following radio channels, frequencies and systems, depending on radio equipment and sea area:
 - a. VHF channel 16 and CHF/DSC channel 70;
 - b. MF/DSC frequency 2187.5 kHz.
- (2) All vessels not safely moored in port shall maintain a radio watch for reception of maritime safety information (MSI), using a NAVTEX receiver or other methods maintaining the same safety function by obtaining relevant weather and navigational warnings through the VHF coast radio, public electronic systems or other public broadcasting.

0 Amended by Regulation of 6 December 2021 No. 3415 (in force on 1 January 2022).

Section 72. Maintenance

- (1) Radio equipment for the sea areas A1 and A2 shall be maintained in order to be kept at all times capable of transmitting distress signals and conducting follow-up emergency communication.
- (2) Float-free satellite EPIRB, as referred to in section 69 fifth and sixth paragraphs, shall at least every five years be inspected by a shore-based company.

Section 73. Radio records

Radio records shall be kept at the place where the listening watch is kept. They shall be available for inspection when authorised persons so require. The following shall be entered in the records:

- a. summary of communication in connection with distress, urgency and safety messages;
- b. important incidents related to the service;
- c. the position of the vessel when the incidents occurred;
- d. overview of maintenance of radio equipment and sources of energy; and

- e. daily/monthly functional test of the radio station, conducted by the radio operator in charge.

Section 74. *Position-updating*

Vessels operating in, or having vessel instructions for, a trade area greater than Fjord fishing shall have equipment automatically updating the position in all radio equipment capable of transmitting distress signals, either by means of an internal navigation receiver or by connecting the equipment to an external navigation receiver.

8. Navigation equipment and wheelhouse arrangement

Section 75. *Compasses*

- (1) All vessels shall have a magnetic compass so placed that it is possible to use the necessary means of correction. The means of correction / correction arrangement shall as far as possible be capable of bringing the deviation within the range of $+5^{\circ}$ to -5° . For vessels constructed after 1 July 1997 the compass shall be in accordance with ISO 613:1982 (ES) magnetic compass class B. A standard magnetic compass may be used as an alternative, provided that it is installed in the binnacle with full height placed as close as practicable to the ship's longitudinal centre line in the wheelhouse. The magnetic compass shall be fitted with a reading arrangement so that the compass heading is clearly readable from the main steering position.
- (2) The placing of the compass installation shall be given priority over the placing of other equipment in the wheelhouse. The placement must be such that the heading is clearly readable from the position of the helmsman and the navigator.
- (3) The magnetic compass shall be corrected in order to determine the deviation when conversions or alterations have been carried out which affect the magnetic conditions where the compass is installed. A deviation table shall be available at all times.
- (4) The compass shall have an illumination arrangement with built-in dimmer which can be adjusted from the main steering position.
- (5) If more than one compass is being used in the same compass installation, none of these shall differ in magnetic moment by more than 15% from that of the compass with the greatest moment.

Section 76. *Automatic pilot system and steering aids*

- (1) For vessels of 10.67 to 15 metres in overall length constructed after 1 July 1997, the automatic pilot system shall be in accordance with recognised standards.
- (2) Vessels having steering aids or an automatic pilot system shall have an indicator for the angle of the rudder, which is readable from the steering position(s).
- (3) If several course adjustment and steering devices are installed, it shall be possible to secure these against inadvertent use.
- (4) It shall be possible to activate and deactivate automatic pilot systems from the helmsman's position.

Section 77. *Bridge navigational watch alarm system*

- (1) Vessels of 10.67 to 15 metres in overall length which are equipped with automatic pilot system / steering aids, shall be fitted with a bridge navigational watch alarm system (BNWAS) if they have vessel instructions for a trade area greater than Fjord fishing.
- (2) The BNWAS shall either be permanently activated, or be activated when the vessel's automatic pilot system is in use, or so configured that it will be activated at the latest when the vessel reaches service speed. The BNWAS shall trigger an audible signal with a time interval not exceeding five minutes if the person in charge of the navigational watch does not acknowledge his or her presence in the wheelhouse. It shall be possible to set the time interval shorter than 5 minutes.
- (3) The BNWAS shall satisfy the functional requirements specified in Appendix 8. A BNWAS satisfying the requirements of IMO Res. MSC.128(75) may as an alternative be used.

Section 78. *Speed and distance measuring device*

Vessels constructed after 1 July 1997 with vessel instructions for trade area Bank fishing II shall be fitted with means of determining the vessel's speed and distance run.

Section 79. *Radar installation*

If vessels of 10.67 to 15 metres in overall length constructed after 1 July 1997 are fitted with a radar installation, the radar installation shall:

- a. be so placed that the operator has a good view of the radar display from the operating position;
- b. have the radar antenna so placed that the quality of the radar image will not be impaired due to short distance to other equipment or to masts, posts, etc.;
- c. have a notice at the radar display unit indicating direction and size of blind sectors, if any; and
- d. have the radar antenna so placed that it does not impair the effect of the other radio equipment.

Section 80. *Electronic position-fixing equipment*

If vessels of 10.67 to 15 metres in overall length are fitted with electronic position-fixing equipment, the equipment shall satisfy the requirements of IMO Res. A.818(19), IMO Res. A.819(19), MSC.112(73) or newer standards prepared by the International Maritime Organization (IMO).

Section 81. *Depth-measuring equipment*

Vessels of 10.67 to 15 metres in overall length constructed after 1 July 1997 shall have equipment for measuring depth below the vessel.

Section 82. *Steering gear, etc.*

- (1) Vessels of 10.67 to 15 metres in overall length constructed after 1 July 1997 which do not have a rudder, but are fitted with a rotating propulsion and steering propeller system, shall have steering gear which functions synchronously with the propulsion power.
- (2) The steering gear shall be so arranged that the vessel turns to the same side to which the wheel or bat handle or similar is moved.

Section 83. *Ship's clock*

The navigator shall have access to a clock at all times for the reading of the correct time.

A clock from a fixed electronic instrument located in the wheelhouse, which is connected to an emergency source of power as described in section 24, may be used.

Section 84. *Binoculars and thermometer*

- (1) Vessels shall be equipped with at least a pair of prismatic binoculars of type 7x50, or 8x35 if appropriate, or other binoculars with equivalent properties.
- (2) Vessels operating in waters where ice may occur shall be fitted with a dedicated thermometer for the measurement of seawater temperatures.

Section 85. *Charts and nautical publications*

Vessels shall be equipped with adequate and up-to-date charts, sailing directions, list of lights, notices to mariners, tide tables and all other nautical publications for the vessel's trade area. Vessels of less than 10.67 metres in overall length may as an alternative use "Norsk Fiskaralmanakk" and necessary charts for the vessel's trade area.

Section 86. *Lights*

- (1) All vessels shall have at least one set of fixed electric lights satisfying the requirements of Regulations of 1 December 1975 No. 5 for preventing collisions at sea.

(2) When all-round lights for practical reasons cannot be fixed in position, loose lights may be used if there are electric connection options and the lights can be safely placed.

(3) Vessels constructed after 1 January 1992 shall have a control panel or control unit for the lights, which satisfies the requirements of Nordic Boat Standard (1990) C11.

Section 87. *Signalling equipment*

(1) Distress signal equipment and signal flags shall be readily available on board.

(2) All vessels shall have one set of shapes as described in the Rules of the Road at Sea, which at least cover the statuses Anchored, Fishing and Not Under Command.

(3) Vessels which are likely to use a pilot, or vessels calling at foreign ports, shall at least be equipped with the signal flags G and H, as well as the flags included in the vessel's call sign.

(4) All vessels shall be provided with means for distress signalling in accordance with Regulations of 1 December 1975 No. 5 for preventing collisions at sea (Rules of the Road at Sea) Annex IV.

(5) Vessels used outside of the Norwegian economic zone shall be provided with the Norwegian merchant flag.

Section 88. *Sound signal apparatuses*

(1) Vessels of 12 to 15 metres in overall length shall have a fixed klaxon/whistle satisfying the requirements of Regulations of 1 December 1975 No. 5 for preventing collisions at sea (Rules of the Road at Sea) Annex III.

(2) The whistle shall be ready for use at all times and be capable of being operated from the navigator's and helmsman's, if appropriate, normal position(s).

(3) The whistle shall be so placed that the intensity of sound at the helmsman's, lookout's and navigator's positions does not exceed 100 dB(A).

(4) Vessels with required sound signalling apparatuses which are dependent on the vessel's main source of energy, must have an extra arrangement in order to be capable of giving the required sound signals.

Section 89. *Searchlight*

Vessels of 12 to 15 metres in overall length constructed after 1 July 1997 and operating in a trade area greater than Fjord fishing, shall have:

- a. searchlight and signalling lamp;
- b. rotatable searchlight which may also be used for signalling; or
- c. transportable signalling lamp which may also be used as searchlight.

Section 90. *Instructions for use, spare parts, etc.*

(1) For equipment in the wheelhouse, instructions for use and maintenance shall be available, in addition to technical specifications in both Norwegian and any other working language.

(2) The necessary tools and spare parts for inspections and repairs expected to be carried out by the crew, along with any equipment for required controls, etc., shall be kept readily available.

Section 91. *Wheelhouse arrangement, view from the wheelhouse, etc.*

(1) For vessels of 10.67 to 15 metres in overall length constructed between 1 July 1979 and 1 January 1992, the following requirements apply:

- a. From the wheelhouse it shall be possible to move so that you have an overview and a view over an arc of the horizon of 360 degrees, regardless of trim and any cranes, tanks, funnels, etc.
- b. In wheelhouses with only one door, it shall be possible to open at least one of the windows on each side of the wheelhouse.
- c. The wheelhouse shall be so arranged that there as far as possible is a view over an arc of the horizon of 360 degrees. Instruments and windows shall be so arranged that no interfering reflections occur.
- d. Instruments and other equipment provided in the wheelhouse must be so placed that they do not obstruct the navigator's view of the weather deck in front of the wheelhouse.

- e. Illumination of instruments in the wheelhouse and chartroom, if any, shall be arranged so that no dazzle effect occurs, and so that any reflections do not obstruct the view and hinder efficient lookout.
 - f. Tables or similar with adequate size shall be provided and appropriately placed with suitable lighting for navigation by charts.
 - g. The helmsman's position shall as far as possible be in the centre line of the vessel. The helmsman's positioning shall not complicate the use and operation of navigation equipment, equipment for remote control of propulsion machinery and equipment in the wheelhouse in connection with operation of periodically unmanned engine-room.
- (2) For vessels of 6 to 15 metres in overall length constructed between 1 January 1992 and 1 July 1997, the following requirements apply:
- a. From the wheelhouse the view forward, to the sides and aft of the wheelhouse shall be good. The front windows shall be capable of being kept free from rain, spray and condensation.
 - b. Instruments, control handles, warning lights, etc. in the wheelhouse shall be appropriately placed.
 - c. Furnishing details on the control console and in the field of vision shall as far as practicable be executed in a non-reflecting material.
 - d. The headroom in wheelhouses shall normally be at least 1.98 metres.
- (3) For vessels constructed after 1 July 1997, the following requirements shall apply:
- a. The view of the sea surface from the wheelhouse/bridge shall not be obscured by more than two vessel lengths forward of the bow to 10° on either side irrespective of the vessel's draught, trim and deck cargo.
 - b. No blind sector caused by fishing gear, cargo-handling equipment or other obstructions outside of the wheelhouse forward of the beam which obstructs the view of the sea surface as seen from the wheelhouse/conning position, shall exceed 10°. No individual blind sectors shall exceed 5°. The total arc of blind sectors shall not exceed 20° of the horizon. The clear sector between two blind sectors shall be at least 5°.
 - c. The horizontal field of vision from the wheelhouse/conning position shall extend over an arc of not less than 225°, that is from right ahead to not less than 22.5° abaft the beam on either side of the vessel.
 - d. From each bridge wing or side of the wheelhouse on vessels of 10.67 to 15 metres in overall length, the horizontal field of vision shall extend over an arc of at least 225°, that is from at least 45° on the opposite bow through right ahead and then from right ahead to right astern over an arc of 180° on the same side of the vessel.
 - e. From the conning position the horizontal field of vision on vessels of 10.67 metres in overall length and upwards, shall extend over an arc from right ahead to at least 60° on each side of the vessel.
- (4) For windows in wheelhouses on vessels of 10.67 to 15 metres in overall length constructed after 1 July 1997, the following requirements apply:
- a. The height from the bridge deck to the lower edge of the front windows in the wheelhouse shall be as low as possible. In no case shall the lower edge of the windows obstruct the forward view.
 - b. The upper edge of the front windows in the wheelhouse shall allow a forward view of the horizon for a person with a height of eye of 180 cm above the deck in the wheelhouse at the conning position.
 - c. Framing between the windows in the wheelhouse shall be kept to a minimum. Framing shall not be installed immediately forward of the conning position.
 - d. Polarised and tinted windows shall not be used.
 - e. A clear vision screen shall be installed in one of the windows in the wheelhouse or a window heater with freshwater rinsing and window wiper. Depending on bridge construction, more such windows shall be installed if necessary, so that the view is clear at all times regardless of weather conditions.
- (5) For wheelhouse arrangements on vessels of 10.67 to 15 metres in overall length constructed after 1 July 1997, the following requirements apply:
- a. The wheelhouse shall be arranged as high as practicable, and so that compliance with the requirements for unobstructed view from the wheelhouse is ensured.
 - b. The size and layout of the wheelhouse shall be such that navigational aids and equipment may be located in an appropriate manner. The navigator(s) shall readily be able to move around, monitor instruments and carry out the required tasks during the navigational watch.

- c. Where instruments are to be located beneath the wheelhouse ceiling, there shall be a headroom of not less than 190 cm so that there is unobstructed visibility and free passage underneath the instruments. The requirement does not apply to the reflector device of the magnetic compass.
- (6) For the fitting and maintenance of navigational aids, the following requirements shall apply:
- a. The fitting of navigational aids shall be carried out or be accepted by a specialist representing the manufacturer.
 - b. Navigational aids shall be located in an appropriate manner, taking into account inspection and maintenance.
 - c. Newly installed navigational aids shall be subjected to a function test under observation by a representative for the manufacturer before the vessel is put into service.
 - d. Navigational aids shall be inspected, maintained and if necessary calibrated or corrected in accordance with the recommendations from the manufacturer.

9. Inspections and documentation

Section 92. *Vessel instructions*

Vessels of 8 to 15 metres in overall length shall have valid vessel instructions indicating vessel data and statutory limitations on the use of the vessel, including information about the length, breadth and draught, maximum trade area and operational restrictions of the vessel.

Section 93. *Coordination of inspections*

Required inspection by an accepted electrical enterprise shall be carried out before or at the same time as inspection by an approved company, so that the inspections can be coordinated.

Section 94. *Inspection of vessels of less than 8 metres*

Vessels of less than 8 metres in overall length are not subject to inspections by an approved company, but may be inspected by way of unscheduled supervision, cf. Act of 16 February 2007 No. 9 relating to ship safety and security section 43.

Section 95. *Inspections of vessels of 8 to 9 metres in overall length*

All vessels of 8 to 9 metres in overall length shall:

- a. be subject to a complete inspection by an approved company;
- b. be subject to a complete inspection by an accepted electrical enterprise. The requirement for a complete inspection by an accepted electrical enterprise does not apply to existing vessels with a valid installation attestation for the electrical installation at the time of the initial inspection by an approved company;
- c. be subject to a control every 30 months by the company (company's control). The company's control may be carried out within six months prior to or after this date, without the date of the next company's control being changed. If the company's control has not been carried out within the mentioned deadlines, the vessel instructions become invalid;
- d. have on board a copy of the form for completed company's control and complete inspection.

0 Amended by Regulation of 6 December 2021 No. 3415 (in force on 1 January 2022).

Section 96. *Inspections of vessels of 9 to 10.67 metres in overall length*

All vessels of 9 to 10.67 metres in overall length shall:

- a. be subject to a complete inspection by an approved company if the vessel has not been subject to a complete or periodic inspection by an approved company during the last five years;
- b. within a period of five years be subject to a periodic inspection by an approved company. The inspection may be carried out within six months prior to this date, without the date of the next inspection being changed;

- c. have completed a preparatory company's control in connection with a complete or periodic inspection before the vessel is subject to an inspection by an approved company;
- d. within a period of 30 months after the last complete or periodic inspection by an approved company be subject to an intermediate periodic control by the company (company's control). The company's control can take place within six months prior to or after this date. If the company's control has not been carried out within the mentioned deadlines, the vessel instructions become invalid;
- e. be subject to a complete inspection by an accepted electrical enterprise. The requirement for a complete inspection by an accepted electrical enterprise does not apply to existing vessels with a valid installation attestation for the electrical installation at the time of the initial inspection by an approved company;
- f. be subject to a periodic inspection by an accepted electrical enterprise within a period of five years of the date for the last complete inspection or of the date for the last periodic inspection by an accepted electrical enterprise. The inspection may be carried out within six months prior to the expiry of the current period, without the date of the next inspection being changed;
- g. keep valid vessel instructions and report form on board.

0 Amended by Regulations of 4 May 2015 No. 445 (in force on 6 May 2015), 6 December 2021 No. 3415 (in force on 1 January 2022).

Section 97. Inspections of vessels of 10.67 to 15 metres in overall length

All vessels of 10.67 to 15 metres in overall length shall:

- a. be subject to a complete inspection by an approved company if the vessel has not been subject to a complete or periodic inspection during the last 30 months;
- b. within a period of 30 months be subject to a periodic inspection by an approved company. The inspection may be carried out within six months prior to this date, without the date of the next inspection being changed;
- c. have completed a preparatory company's control in connection with a complete or periodic inspection before the vessel is subject to an inspection by an approved company;
- d. be subject to a complete inspection by an accepted electrical enterprise if the vessel has not been subject to a complete or periodic inspection during the last five years;
- e. be subject to a periodic inspection by an accepted electrical enterprise within a period of five years of the date for the last complete inspection or of the date for the last periodic inspection by an accepted electrical enterprise. The inspection may be carried out within six months prior to the expiry of the current period, without the date of the next inspection being changed;
- f. keep valid vessel instructions and report form on board.

0 Amended by Regulation of 6 December 2021 No. 3415 (in force on 1 January 2022).

Section 98. Reporting of inspections by approved company and company's control

(1) A complete inspection by an approved company of vessels that are newbuildings, purchased from abroad or subject to conversion, shall be reported by the approved company in accordance with the form laid down by the Norwegian Maritime Authority. This form can be downloaded from www.sdir.no.

(2) A complete and periodic simplified inspection by an approved company of sailing vessels and intermediate company's control shall be reported by the approved company in accordance with the form laid down by the Norwegian Maritime Authority. This form can be downloaded from www.sdir.no. Before a complete or periodic simplified inspection as referred to in section 95 first paragraph (a), section 96 first paragraph (a) and (b), or section 97 first paragraph (a) and (b), the company or master of the vessel shall have submitted a completed form for company's control for the complete or periodic simplified inspection to the approved company in accordance with the form laid down by the Norwegian Maritime Authority. This form can be downloaded from www.sdir.no.

(3) Company's control of vessels of 8 to 9 metres in overall length shall be reported directly to the Norwegian Maritime Authority in accordance with the form laid down by the Norwegian Maritime Authority. This form can be downloaded from www.sdir.no.

(4) Intermediate company's control of vessels of 9 to 10.67 metres in overall length shall be reported directly to the Norwegian Maritime Authority in accordance with the form laid down by the Norwegian Maritime Authority. This form can be downloaded from www.sdir.no.

0 Amended by Regulation of 6 December 2021 No. 3415 (in force on 1 January 2022).

Section 99. *Other inspection of vessel in connection with damage, conversion, trading permit, etc.*

(1) All vessels of 8 to 15 metres in overall length which have been damaged or have undergone repairs, alterations, modifications or outfitting shall be subject to an inspection by an approved company. The inspection shall include the damaged and repaired parts, the components which have been altered or modified, as well as other parts of the vessel affected by the changes made, unless it is necessary to inspect other parts as well to ensure that the requirements for the vessel are satisfied.

(2) Approved companies may, upon written application, issue trading permit for one single journey for a period of up to seven days when the following requirements are met:

- a. It is necessary in connection with inspection, repair or rebuild of the vessel.
- b. It is considered justifiable in terms of health and safety, and any compensating measures to maintain an acceptable level of safety.

(3) A trading permit shall be issued on a form which can be downloaded from www.sdir.no

0 Amended by Regulation of 6 December 2021 No. 3415 (in force on 1 January 2022).

Section 99a *Inspection of lifting equipment*

(1) On vessels of 9 metres or more in overall length, lifting equipment with a lifting capacity of up to and including 500 kg and up to 2 ton metres shall be approved by an approved company in accordance with the requirements of these Regulations in connection with initial and periodic inspections. This requirement also applies to vessels of 8 to 9 metres in overall length that are certified as fishing vessels for the first time after 1 January 2023. Alternatively, crane approvals may be carried out by a competent person in accordance with the Regulations of 17 January 1978 No. 4 on cargo-handling appliances in ships.

(2) An annual inspection of the lifting equipment shall be carried out. The annual inspection shall include a function test and a visual inspection to detect any elongation, wear and tear, corrosion, cracking and formation of fractures, etc. The annual inspection can be carried out by a workshop, approved company or other company, or by a person competent to do so.

0 Added by Regulation of 6 December 2021 No. 3415 (in force on 1 January 2022).

Section 100. *Inspection of the electrical installation by an accepted electrical enterprise*

(1) All inspections by accepted electrical enterprises shall be carried out in accordance with the report form laid down by the Norwegian Directorate for Civil Protection. For classed vessels, the inspection of the electrical installation may be carried out by recognised classification societies.

(2) The vessel is under an obligation to be subject to other inspection by an accepted electrical enterprise to ensure that the vessel's condition is still in compliance with the currently applicable regulations, when:

- a. the electrical installation is altered or modified; and
- b. the electrical installation has been damaged or undergone repairs.

(3) Inspections as referred to in the second paragraph shall include the parts that have been damaged or undergone repairs, alterations or modifications. The inspection shall also include other parts if this is necessary in order to ensure that the condition of the vessel is still in compliance with the regulations in force at the time of inspection.

Section 101. *Documentation for newbuildings and conversions*

When building or converting vessels of 8 to 15 metres in overall length, drawings and other documentation shall be checked by an approved company.

0 Amended by Regulation of 6 December 2021 No. 3415 (in force on 1 January 2022).

Section 102. Documentation on board the vessel

- (1) Documentation which pursuant to these Regulations is required to be kept on board, shall also be available for presentation at later inspections/supervision.
- (2) In addition to documentation referred in the individual provisions, the following shall be kept on board:
 - a. Vessels of 6 to 8 metres in overall length shall have an installation attestation for electrical installations.
 - b.) Vessels of 8 to 15 metres in overall length shall have a report form for electrical installations issued by an accepted electrical enterprise. For existing vessels of 8 to 9 metres in overall length, a valid installation attestation is accepted as documentation for the electrical installation. If the Norwegian Directorate for Civil Protection so accepts, the report form and installation attestation may be replaced by a declaration of survey.
 - c. Vessels of 6 to 15 metres in overall length shall have on board a record book for cargo-handling appliances as referred to in Regulations of 17 January 1978 No. 4 on cargo-handling appliances in ships.
 - d. New and existing vessels constructed after 1 July 2007 of 6 to 8 metres in overall length shall have a confirmation of construction.
 - e. Existing vessels of more than 8 metres constructed after 1 July 2007 shall keep on board a confirmation of construction until a complete inspection pursuant to section 95 and section 96 has been carried out by an approved company.
- (3) The owner of the vessel is responsible for ensuring that the main manufacturer/yard, including the builder of semi-products/DIY builders, as well as the importer issue a confirmation of construction on the form prescribed by the Norwegian Maritime Authority.
- (4) A certificate of installation for gasfired installations shall be kept on board.
- (5) A description of the fire-extinguishing system with instructions for use and maintenance of the system in accordance with the manufacturer's instructions shall be kept on board.
- (6) Letter concerning inspection of stability calculations, stability poster and other stability documentation shall be kept on board the vessel.
- (7) A declaration of conformity from manufacturer of liferaft shall be kept on board.
- (8) Documentation of pressure-testing/tightness-testing of immersion suits shall be kept on board.

0 Amended by Regulations of 4 May 2015 No. 445 (in force on 6 May 2015), 26 October 2020 No. 2142, 6 December 2021 No. 3415 (in force on 1 January 2022).

10. Concluding provisions

Section 103. Exemptions and equivalents

- (1) The Norwegian Maritime Authority may exempt a ship from one or more of the requirements of the Regulations when the company applies for an exemption in writing and one of the following conditions is met:
 - a. it is established that the requirement is not essential and that it is justifiable in terms of safety;
 - b. it is established that compensating measures will maintain the same level of safety as the requirement of these Regulations.
- (2) The Norwegian Maritime Authority may upon application accept other solutions as equivalent to the requirements of these Regulations, when documentation from tests establishing that the solutions are equivalent is submitted.

Section 104. *Entry into force*

These Regulations enter into force on 1 January 2014. As from the same date, the following regulations are repealed:

- a. Regulations of 18 August 1978 No. 9154 on navigational aids, etc. on fishing vessels;
- b. Regulations of 4 September 1987 No. 743 on fire safety measures in fishing vessels as regards vessels of less than 15 metres;
- c. Regulations of 15 October 1991 No. 708 on the construction and equipment of fishing vessels of from 6 m and up to 15 m in overall length;
- d. Regulations of 15 October 1991 No. 709 on life-saving appliances, etc. in fishing vessels as regards vessels of less than 15 metres;
- e. Regulations of 15 October 1991 No. 710 on safety measures, etc. on fishing vessels;
- f. Regulations of 22 December 1993 No. 1242 on radio installations and radio services on fishing vessels;
- g. Regulations of 3 October 2000 No. 985 on the supervision of fishing vessels of from 10.67 to 15 m in overall length.

Section 105. *Transitional provisions*

(1) For vessels of 8 to 10.67 metres in overall length, except vessels as referred to in the third and fourth paragraphs, the requirements of chapter 9 on inspection by an approved company and the requirements for stability documentation will be applicable from:

- a. 1 July 2014 for new vessels;
- b. 1 January 2016 for existing vessels constructed on or after 1 January 1998;
- c. 1 January 2017 for vessels constructed in the period from 1 January 1992 to 31 December 1997;
- d. 1 January 2019 for vessels constructed in the period from 1 January 1983 to 31 December 1991;
- e. 1 January 2020 for vessels constructed in the period from 1 January 1970 to 31 December 1982;
- f. 1 January 2021 for vessels constructed before 1970.

(2) For vessels of 9 to 10.67 metres in overall length, the first complete inspection by an approved company may be carried out within 18 months prior to the transitional dates of the first paragraph without the date of the next inspection being changed. For subsequent inspection, the provisions of section 96 apply.

(3) Regardless of the provision of the first paragraph, the requirements of chapter 9 on inspection and documentation will be applicable to vessels of 8 to 10.67 metres in overall length constructed before 1 January 1992, from:

- a. 1 January 2016 for all vessels operating in trade area Bank fishing I;
- b. 1 January 2019 for all vessels operating in trade area In-shore fishing.

(4) For vessels constructed before 1 January 1992 operating in trade area Fjord fishing, except vessels fishing with seines and taking their catch on board, the requirements of chapter 4 on stability calculations will be applicable from:

- a. 1 January 2022 for vessels of 8 to 9 metres in overall length;
- b. 1 January 2021 for vessels of 9 to 10.67 metres in overall length.

(5) For vessels of 10.67 to 15 metres in overall length constructed before 1 January 1992 and operating in trade area Fjord fishing, except vessels fishing with seines and taking their catch on board, the requirements of chapter 4 on stability calculations will be applicable from 1 January 2020.

(6) Existing vessels may have radio equipment in accordance with Regulations of 22 December 1992 No. 1242 on radio installations and radio services up until:

- a. 1 January 2032 for vessels of less than 8 metres in overall length;
- b. 10 years after the issue of vessel instructions for vessels of 8 to 10.67 metres in overall length;
- c. 1 January 2025 for vessels of 10.67 to 15 metres in overall length.

(7) The requirement for EPIRB of section 68 nevertheless applies from 1 July 2014.

An EPIRB without integrated position indicator, procured before 1 July 2014, may be used until 1 July 2018.

(8) For vessels that have not previously been registered in the Register of Norwegian Fishing Vessels, the requirements of chapter 9 on inspection by an approved company and the requirements for stability documentation will be applicable from the time the vessel is put into service, regardless of the provisions of the first to fourth paragraphs.

0 Amended by Regulation of 4 May 2015 No. 445 (in force on 6 May 2015).

Appendix 1. Overview - inspections of fishing vessels of less than 15 metres in overall length

<i>Vessel group</i>	<i>Inspections</i>	<i>Inspections</i>	<i>Inspections</i>	<i>Inspections</i>	<i>Inspections</i>
<8 metres	Not subject to inspection by approved company or accepted electrical enterprise				
8-9 metres	Initial inspection by an approved company. Thereafter only requirement for company's controls unless the vessel is altered/modified.	Company's control shall be carried out every 30 months after the date of issued vessel instructions +/- 6 months.) Forms for company's control shall be kept on board (shall not be sent to approved company or the Norwegian Maritime Authority)		Complete inspection by an accepted electrical enterprise (thereafter no periodic simplified inspection by an accepted electrical enterprise)	
9-10.67 metres	Complete inspection by an approved company if the vessel has not been subject to a complete or periodic simplified inspection by an approved company during the last five years	Intermediate periodic control carried out by the company (company's control) The control shall be carried out 30 months after the date of issue of the vessel instructions +/- 6 months	Periodic simplified inspection by an approved company within a period of five years (with preceding preparatory company's control). The inspection shall be carried out 30 months after the date of issue of the vessel instructions -6 months	Complete inspection by an accepted electrical enterprise	Periodic simplified inspection by an accepted electrical enterprise

10.67-15 metres	Complete inspection by an approved company if the vessel has not been subject to a complete or periodic simplified inspection during the last 30 months	Periodic simplified inspection by an approved company (with preceding preparatory company's control). The inspection shall be carried out 30 months after the date of issue of the vessel instructions -6 months		Complete simplified inspection by an accepted electrical enterprise	Periodic simplified inspection by an accepted electrical enterprise
-----------------	---------------------------------------------------------------------------------------------------------------------------------------------------------	------------------------------------------------------------------------------------------------------------------------------------------------------------------------------------------------------------------	--	---------------------------------------------------------------------	---------------------------------------------------------------------

Appendix 2. List of documentation to be kept on board the vessel

0 Amended by Regulation of 6 December 2021 No. 3415 (in force on 1 January 2022).

(Reference is also made to chapter 8 for documentation of radio equipment.)

<i>Vessel size</i>	<i>Legal basis</i>	<i>Document type</i>	<i>Remark</i>
All vessels of less than 15 metres			
	Section 102	Certificate of installation, declaration of survey or report form for electrical installations	Depending on vessel size and date of the first complete inspection by an approved company
	Section 102	Register for cargo-handling appliances	If such equipment is provided on board
	Section 102	Certificate of installation for gasfired installations	If such equipment is provided on board
	Section 102	Description of the fire-extinguishing system with instructions for use and maintenance	If such equipment is provided on board
	Section 36	Posters or placecards with information about the placement, treatment and use of lifejackets	
	Section 102	Documentation of pressure-testing/tightness-testing of immersion suits	If such equipment is provided on board
	Section 102	Declaration of conformity for liferaft from the manufacturer.	If such equipment is provided on board
6 to 8 metres	Section 102	Confirmation of construction	Applies new and existing vessels constructed after 1 July 2014
6 to 15 metres	Section 102	Stability documentation	If stability calculations are required pursuant to section 26
8 to 15 metres	Section 92	Valid vessel instructions	

	Section 102	Form for complete inspection	
9 to 10.67 metres	Section 102	Form for company's periodic control	

Appendix 3. Fire insulation

0 Amended by Regulation of 6 December 2021 No. 3415 (in force on 1 January 2022), previously Appendix 4).

1. If necessary, a sheeting of galvanized steel or aluminium shall be provided over the insulation. An outside plate of galvanized steel or aluminium shall be fitted with distance pieces of non-combustible material in a distance of at least 2 cm from the bulkhead insulation. The outside plate shall terminate at least 5 cm above the floor or bench and shall not be covered with mouldings, etc. which may prevent vertical air circulation between the plates. The insulation shall be extended at least 30 cm above the stove. Where this method of insulation is used for smoke uptakes carried along a bulkhead, the outside plate shall be terminated at least 5 cm below the deck. The plates shall not be painted. The stove shall be placed at least 8 cm from the outside plate.

2. Alternatively, a non-combustible plate of at least 19 mm thickness can be fitted with distance pieces of non-combustible material so that the distance between the plate and the bulkhead is at least 5 cm. A galvanized steel or aluminium plate is then fixed to the plate. The plates shall terminate 5 cm above the floor or bench and shall not be covered with mouldings, etc. which may prevent vertical air circulation between the plates and the bulkhead. The insulation shall be extended at least 30 cm above the stove. Where this insulation method is used for funnel uptakes carried along a bulkhead, cf. section 13 third paragraph, the outside plate shall be terminated at least 5 cm below the deck. The plates shall not be painted. The stove shall be placed at least 5 cm from the plate.

3. If necessary, a sheeting of galvanized steel or aluminium shall be provided over the insulation.

Appendix 4. Guidelines for type-approval of fixed fire detection and fire alarm systems on fishing vessels

0 Amended by Regulation of 6 December 2021 No. 3415 (in force on 1 January 2022, previously Appendix 5).

Part I. Provisions on type-approval of fixed fire detection and fire alarm systems on fishing vessels

1. Introduction

1.2. Fishing vessels of 10.67 metres in length and upwards, but less than 15 metres, shall be fitted with a fixed fire detection and fire alarm system for machinery spaces and smoke alarm system for the cabins, which shall be type-approved, cf. section 15 first paragraph on fire detection and fire alarm systems.

The type approval of such systems shall be carried out in accordance with the procedure for approval of central alarm panels and of detectors specified in paragraph 2 below.

2. Procedure for approval of simpler fire detection and fire alarm systems and smoke alarm systems in fishing vessels of less than 15 m.

2.1. As a minimum, the central shall be capable of giving an audible alarm with intermittent signals if one or more detectors activate the alarm.

2.2.

2.3. The central shall give an audible fault alarm in the event of faults in:

2.3.1 power supply

2.3.2 charging current circuit

2.3.3 detector loops

- 2.3.4 the circuit for the alarm instrument.
- 2.4 The central shall be capable of providing an output voltage which is sufficient for the number of alarm instruments served by the central.
- 2.5. In vessels of less than 15 m the electricity supply may come from only one accumulator battery which is being automatically charged. The accumulator battery shall have a sufficient capacity to supply the fire detection and fire alarm systems and the smoke alarm system with the necessary electric power for a period of at least 18 hours, including at least 5 minutes' operation of the alarm instruments, without charging while maintaining the battery voltage throughout the whole discharging period within 12 per cent above or below the battery's nominal voltage.
- 2.6. The central and the installation material shall be suited to the environment to which they will be exposed.
- 2.7. Detectors shall be approved in accordance with the procedure specified in the enclosed annex 2.

Annex 1 to Part I. Procedure for approval of central alarm panels

1. Documentation

The following documentation shall be provided for approval:

- instructions for use, including procedure for routine testing on board
- fault-finding procedures, sufficiently detailed for localizing faults to sub-systems which can be replaced by a qualified officer
- data on power supply
- connection of detector loops and external auxiliary equipment such as external alarms, fan stopper, door magnets etc.
- installation instructions
- list of components with specifications of make and type of replaceable components
- detailed description of function and construction
- drawings showing mechanical construction and assembly
- environmental specification showing threshold values for the external environment in which the central alarm panel can operate
- reports from tests carried out.

The documents marked "-" shall be delivered on board each ship together with the alarm installations.

2. Functional requirements

- 2.1. The central alarm panel shall at least give an audible alarm in the event of fire. If a visual alarm is also given, it shall be given by means of a red lamp marked "BRANN" or "BRANN/FIRE".
- 2.2. The central alarm panel shall indicate in what area fire has broken out.
Fire alarm: Non-continuous alarm with the alarm system or intermittent signals with the vessel's whistle.
- 2.4. A visual and/or audible fault indication shall be given in the event of a fault which will involve a reduction in the ability to detect or indicate fire. Fault indication shall be given in the event of an earth fault, short-circuiting or loop failure.
- 2.5. Visual and/or audible fault indication shall be given in the event of failure of the main or emergency power supply. «Failure of power supply» means that the voltage drops below the limits specified during the environmental test.
- 2.6. Visual fault indication shall be given by a yellow lamp marked "FEIL" or "FEIL/ FAULT".
- 2.7. The alarm panel shall automatically switch over to the emergency power supply in the event of a voltage drop. It shall not be possible for the alarm panel to relay faulty information when switched from normal to emergency power supply.
- 2.8. It shall be possible in a simple way to carry out realistic function testing of the fire alarms for all detector loops and all fault-indicating arrangements.

- 2.9. When disconnection of functions is possible from the alarm panel by means of a switch or similar arrangement, a positive indication shall be given on the panel.
- 2.10. A positive indication shall be given that the power supply is intact. Numerical indication of the operating voltage is not required.
- 2.11. It shall be possible to acknowledge an audible fire or fault indication by means of a single push button or similar, leaving detector loops still in a state of alarm. Audible and visual fire alarms must not be blocked by an existing fire alarm on another detector loop when the existing alarm has been acknowledged.
- 2.12. It shall be possible to use the central alarm panel, if necessary with adapting equipment, together with the following types of detectors:
 - maximum temperature detectors
 - differential temperature detectors
 - radiation detectors: ultra-violet, infra-red
 - smoke detectors: visual, ionization.

It shall also be possible to use the central alarm panel with a combination of these types of detectors coupled together in the same detector loop, using adapting equipment if necessary.

3. Construction requirements

- 3.1. Visual and audible alarm circuits shall be so designed and constructed that a single fault in the circuits does not prevent both types of signals from functioning.
- 3.2. The alarm panel shall be so arranged that no disturbing light signals occur during normal operation and so that there is no possibility of warning apparatuses being activated by an inadvertent touch of the central alarm panel.
- 3.3. The central alarm panel shall be designed and constructed to withstand the environmental conditions specified in IEC publication No. 60092-504, in addition to satisfying the requirements for protection grade IP42 pursuant to IEC publication No. 60529.
- 3.4. The central alarm panel shall have possibilities of having detectors connected to it which satisfy failsafe requirements, i.e. that short circuits or rupture of the cable connection between the central alarm panel and detectors, or between detectors, shall initiate fault or fire indication.
- 3.5. The central alarm panel shall have wire connection clamps for two separate power supply lines.
- 3.6. The central alarm panel shall have an adequate number of potential-free output contacts (or equivalent) arranged for connection to a suitable external alarm system. Potential-free breaking contacts or equivalent shall be used to indicate faults over the general machinery spaces alarm system. Similarly, auxiliary contacts shall be provided for control signals to fan motors, door magnet holder etc.

4. Environmental requirements

- 4.1. Central alarm panels shall satisfy the requirements specified in IEC publication No. 60092-504.
- 4.2. Central alarm panels shall not be sensitive to electrical interference from signal and power lines of the magnitude that may be induced from other electrical equipment on board the ship.

5. Test programme

- 5.1. Before a central alarm panel is submitted for approval, it shall have undergone environmental testing at a recognised testing laboratory or have undergone tests in the presence of a representative of the Norwegian Maritime Authority. Documentation and reports from the tests shall be available.
- 5.2. Testing shall be carried out in accordance with the block diagram.

(Figure 1 omitted.)

- 5.3. At each stage of the environmental test, the test object shall undergo a function test. This test shall consist of a series of test sequences which collectively cover all functions of the equipment. Each sequence shall consist of the following stages:
 - a. Initiate fire alarm in loop X
 - b. Switch off external sirens
 - c. Switch off local buzzer
 - d. Re-set alarm circuit

e. Re-set local and external signals.

At each of these stages the condition of the object shall be observed in order to detect malfunctioning.

5.4. Function test (IEC 60068-1)

Before environmental tests are carried out a function test must be completed under standard atmospheric conditions:

- Temperature: +15°C to +35°C
- Relative humidity: 45-75 per cent
- Atmospheric pressure: 860-1,060 millibars

No importance shall be attached to other atmospheric parameters. Function testing shall be carried out between each of the subsequent environmental tests, and shall comprise all control functions, as well as fault indicating and alarm functions.

5.5. Variation in power supply

Operating voltage shall be varied within the given limits. During the test checks shall be carried out to ascertain that malfunction does not occur.

- Mains voltage: +10/-15 per cent
- Battery voltage: +/-17 per cent.

5.6. Heat test (IEC 68-2-2)

- Temperature: +55°C +/-3°C
- Duration: 16 hours
- Absolute humidity: 20 g of water per m³ of air

The test object shall be placed in a chamber at room temperature (15°C to 35°C). Then the temperature shall be raised to +55°C and kept constant for at least 16 hours. The temperature shall then again be lowered to room temperature.

The alarm panel shall be in operation during the test and shall be function tested. The function test shall not be carried out earlier than minimum two hours after the temperature of 55°C has been reached in the chamber.

5.7. Vibration test

The installation during the test shall be equivalent to that which the equipment will have in practice. Vibrations shall be applied from three directions bearing on each other at right angles. The following requirements shall be satisfied:

- 2.0-13.2 Hz: +/-1 mm constant position amplitude
- 13.2-80.0 Hz: +/-0.7 constant acceleration amplitude

Testing according to Random vibration tests may be accepted.

Resonance scanning test

The full frequency range shall be scanned with a frequency change of maximum 1 octave per minute. The test object shall be in operation during the scanning test.

Resonance endurance test

A 90-minute endurance test shall be carried out for each resonance frequency. If no resonance is found in one direction, a two-hour endurance test shall be carried out at 25 Hz. The test object shall be in operation during the endurance test.

Sweep endurance test

A 90-minute endurance test shall be carried out with automatic frequency sweep as during the resonance scanning test.

Final resonance scanning test

This test shall be carried out to determine whether the test object has been mechanically impaired by the endurance test. If so, a shifting of the resonance frequencies will take place. The test object shall be in operation during this test.

5.8. Humid heat test, cyclic (IEC 68-2-30)

The test object shall be exposed to two cycles and be disconnected during this test in order to avoid heating which will counteract condensation. Test conditions: +55°C/two cycles. The function test shall be carried out after the end of the second 24-hour cycle and after the end of the normalisation period mentioned in paragraphs 5 and 7 of IEC 68-2-30.

5.9. Salt mist

The following test shall be carried out:

- Testing temperature: +35°C +/-2°C
- Duration: 24 hours
- Solution: 50 g +/-1 g NaCl + distilled or ionexchanged water = 1 litre of solution at 20°C, 6.5 pH 7.2.

The individual components of the test object shall be visually inspected after the test and function testing shall be carried out.

Annex 2 to Part I. Procedure for approval of detectors

1. Documentation

The following documentation shall be provided for approval:

- instructions for installation and assembly
- maintenance instructions
- procedure for routine testing on board
- procedure for type testing
- information on loop connection
- drawings showing mechanical construction and assembly
- technical specifications, with sensitivity data and time response
- environmental specifications stating threshold values for the external environment in which the detector is capable of operating.

Documentation marked "-" shall be delivered to each ship together with the installation.

2. Functional requirements

2.1. General requirements

- a. Detectors shall give warning of fire, signalling this to the central alarm panel.
- b. Detectors shall have adequate sensitivity to give warning of fire at an early stage of development.
- c. Detectors should be designed and constructed with means of adjusting their sensitivity.
- d. Detectors shall have adequate selectivity not to give frequent false undesired alarms.
- e. Detectors which have to be re-set manually shall give visual indication after activation.
- f. Detectors shall give indication of faults reducing the ability to indicate fire.
- g. It shall be possible to carry out easy function testing of detectors.

2.2. Special requirements

- a. Existing detectors are based upon the following principles:
 - Thermal detection:
 - Absolute
 - Differential
 - Smoke detection:
 - Visual
 - ionization chamber

- Radiation detection:
 - infra-red
 - ultra-violet

Detectors based on other principles will be individually evaluated.

- b. All types of detectors shall satisfy the tests contained in item 5 - Test programme.
- c. UV detectors shall not be sensitive to light of wavelengths greater than 0.29 µm.

Note: The 0.29 µm limit has been chosen because sunlight contains rays of greater wavelengths and might therefore give rise to undesired false alarms.

3. Construction requirements

- 3.1. Detectors shall withstand the environmental conditions specified in IEC publication no. 92-5-4, Part 3, and satisfy the requirements for protection grade IP 42 pursuant to IEC publication 529. This protection requirement does not apply to those parts of the detector which – owing to the principle of detection – must be in direct contact with ambient air.
- 3.2. Detectors which remain in the alarm state after activation shall be capable of being easily replaced or re-set.
- 3.3. Thermal detectors shall be provided with two independent contact points.
- 3.4. Signal output from detectors shall be designed so that they can be connected with other detectors in a loop.
- 3.5. Detectors shall be provided with lead-ins for cables of a type approved for installation in ships.

4. Environmental requirements

- 4.1. Detectors shall satisfy the environmental requirements specified in IEC publication 92-5-4, Part 5, and shall withstand the thermal, mechanical, and chemical strains and stresses they may be exposed to when installed on board a ship.
- 4.2. Detectors shall not be sensitive to electrical interference from signal and power supply cables of the magnitude that may be induced from other electrical equipment on board a ship.

5. Test programme

Before a detector is submitted for approval, it shall have undergone environmental testing at a recognized testing laboratory. Documentation and reports from the tests shall be furnished. Testing shall be carried out in accordance with the block diagram. (Figure 1 omitted.)

5.1. Fire test

Prior to the environmental test, the detector shall undergo a "fire test". At this test the detector shall be exposed to realistic conditions in the form of smoke, radiation and heat.

- a. Thermal detectors shall be tested in accordance with CEN 54, Part 5, (EN 54, Part 5). (CEN = CENELEC: The European Committee for Electro-Technical Standardization)
- b. Smoke detectors shall be tested in a smoke duct. Their sensitivity shall then be in the range of 0.2 × 0.65.

Sensitivity factor $x = (I_o - I_a) / I_o$

I_o = ion chamber current in normal condition

I_a = ion chamber current in alarm condition

Other types of smoke tests may be approved in each individual case.

- c. Radiation detectors shall be subjected to radiation from a «standard test flame» from a distance of 5 meters. The time response shall not exceed 5 seconds.

Furthermore, the sensitivity of the radiation detectors to other sources of light shall be examined. These sources of light are:

- Sunlight
- electric arc
- light from an incandescent lamp
- direct light from a halogen lamp

- light from an electric fluorescent tube
- acetylene welding flame.

The light shall be both steady and intermittent with a frequency of approximately 10 Hz. Sensitivity and time response shall be registered in order to gain an impression of the sensitivity of the detector to false symptoms of fire.

Specification of standard test flame:

The flame from a vessel measuring 300 × 300 × 150 mm containing 1 litre of diesel oil and 0.25 kg of cotton waste. Oil temperature 50-60°C.

5.2. Environmental test

- a. At each stage of the environmental test the detector shall undergo a function test. This test shall be simple to carry out, and shall be reproducible so that it provides a quantitative measurement of any alteration in the performance of the detector during the test. The manufacturer shall submit proposals for the procedure of a function test which satisfies these requirements.

The fire test prescribed in item 5.1 may also be used as a function test.

- b. During the environmental test the time response and sensitivity of the detector shall be noted so that major changes during the test shall result in the detector being subjected to closer examination, and possible rejection.
- c. Thermal detectors shall be tested in accordance with CEN 54, Part 5 (EN 54, Part 5).

d. The environmental test shall be carried out in accordance with the block diagram in Figure 1. (Figure 1 omitted.)

5.3. Function test (IEC 68-1)

- a. Before the environmental tests are carried out, a function test shall be completed under standard atmospheric conditions:
 - Temperature: +15°C to +35°C
 - Relative humidity: 45-75 per cent
 - Atmospheric pressure: 860-1,060 millibars

No importance shall be attached to other atmospheric parameters.

- b. Function testing shall be carried out between each of the subsequent environmental tests, and shall comprise all control functions, as well as fault indicating and alarm functions.

5.4. Variation in power supply

Operating voltage shall be varied within the given limits. During the test, checks shall be carried out to ascertain that malfunction does not occur.

- Mains voltage: +10/-15 per cent
- Battery voltage: +/-17 per cent.

5.5. Heat test (IEC 68-2-2)

- Temperature: +55°C +/-3°C
- Duration: 16 hours
- Absolute humidity: 20 g of water per m³ of air

The test object shall be placed in a chamber at room temperature (15°C to 35°C). Then the temperature shall be raised to +55°C and kept constant for at least 16 hours. The temperature shall then again be lowered to room temperature.

The detector shall be in operation during the test and shall be function tested. The function test shall not be carried out earlier than minimum two hours after the temperature of +55°C has been reached in the chamber. Detectors which cannot be subjected to a heat test shall be individually evaluated.

5.6. Vibration test

The installation during the test shall be equivalent to that which the equipment will have in practice. Vibrations shall be applied from three directions bearing on each other at right angles. The following requirements shall be satisfied:

2.0-13.2 Hz: +/-1 mm constant position amplitude
13.2-80.0 Hz: +/-0.7 constant acceleration amplitude

Testing according to Random vibration tests may be accepted.

Resonance scanning test

The full frequency range shall be scanned with a frequency change of maximum 1 octave per minute. The test object shall be in operation during the scanning test.

Resonance endurance test

A 90-minute endurance test shall be carried out for each resonance frequency. If no resonance is found in one direction, a two-hour endurance test shall be carried out at 25 Hz. The test object shall be in operation during the endurance test.

Sweep endurance test

A 90-minute endurance test shall be carried out with automatic frequency sweep as during the resonance scanning test.

Final resonance scanning test

This test shall be carried out to determine whether the test object has been mechanically impaired by the endurance test. In that event, a shifting of the resonance frequencies will take place. The test object shall be in operation during this test.

5.7. Humid heat test, cyclic (IEC 68-2-30)

The test object shall be subjected to two cycles and shall be disconnected during this test in order to avoid heating which will counteract condensation. Test conditions: +55°C/two cycles. The function test shall be carried out after the end of the second 24-hour cycle and after the end of the normalization period mentioned in paragraphs 5 and 7 of IEC 68-2-30.

5.8. Salt mist

The following test shall be carried out:

- Testing temperature: +35°C +/-2°C
- Duration: 24 hours
- Solution: 50 g +/-1 g NaCl + distilled or ionexchanged water = 1 litre of solution at 20°C, 6.5 pH 7.2.

The individual components of the test object shall be visually inspected after the test, and function testing shall be carried out.

Part II. Guidelines for installation and approval of fixed fire detection and fire alarm systems and smoke alarm systems on fishing vessels

1. General.

- 1.1. Pursuant to section 15 of the Regulations, fishing vessels shall be fitted with fixed fire detection and fire alarm systems.
- 1.2. The procedure for type-approval of such systems is specified in Provisions relating to the type-approval of fixed fire detection and fire alarm systems in fishing vessels.
- 1.3. The guidelines below indicate a norm for the installation of such systems. Other solutions providing a similar standard may be accepted.

2. Guidelines for installation

- 2.2.1. The engine-room shall be fitted with 1 smoke detector and 1 heat detector. Public spaces and cabins shall each be fitted with 1 smoke detector. 1 alarm instrument shall be installed in the wheelhouse and 1 in the accommodation, the size of the vessel taken into consideration.
- 2.2.3.
- 2.2.4. Detectors and alarm instruments shall be installed on watertight coupling boxes.

Annex 1 to Part II. Guidelines for the Selection and Location of Detectors in Machinery Spaces

1. In order to achieve optimal monitoring of machinery spaces, a complete detector installation should consist of a combination of:

- thermal detectors;
- smoke/ion detectors;
- flame detectors.

2. Figure 1 (omitted) shows a cross section of typical machinery spaces with the locations of the various types of detectors sketched in. In conjunction with this diagram, general advice is given below on the use and location of detectors.

Thermal detectors

This type of detector is most suitable for small spaces having little or no ventilation, and where it is possible to install the detector closely above the object to be monitored.

Smoke/ion detectors

These detectors have a more general field of application and may be used practically anywhere in machinery spaces with comparatively high sensitivity. However, the use of smoke/ion detectors should be avoided in areas having a particularly high rate of ventilation and also in areas where free exhaust will occur from time to time.

Flame detectors

The flame detector is the type that reacts the most rapidly to a fire where there are flames, and it is also unaffected by ventilation conditions. It should therefore be used in areas of particularly high fire hazard (top of main engine, auxiliary engines/generators, boilers etc.) and in areas where circumstances make it difficult to use the other two types of detectors mentioned above.

3. Location of smoke/ion detectors

In order to ensure the best possible siting, the final location of these smoke detectors should be based on smoke tests under normal operating conditions. It is therefore recommended that these detectors should first be installed with «loose» loop cables, so that they may subsequently be moved within a reasonable area, depending on the smoke test results.

4. It is recommended that the detector installation should be based on universal loops with universal sockets, so that one detector type may be replaced by another at a later stage, if experience should call for it.

Annex 2 to Part II. Guidelines for approval of Fire Detection and Alarm Equipment when installed

Before a fire detection and alarm installation may be approved, the completed installation shall be subjected to:

- a. Function tests
- b. Sensitivity tests

Final approval will depend on favourable results of these tests.

1. Function tests

1.1. Function tests of central alarm panels, power supply, and all warning/alarm instruments.

These tests shall comprise all control, fault indicating and alarm functions. Alarm and loop malfunctions shall be tested by simulation applied at the loop infeeds to the central alarm panel. Function testing of the power supply shall include automatic switching from main to emergency power supply and maximum load tests of both power supplies, which shall last at least 30 minutes in the case of the main supply and 5 minutes for the emergency supply.

Functions such as closing of doors, stopping of fans, etc. shall be checked at the respective locations.

1.2. Function tests of detector loops.

These tests shall comprise testing of all detectors in all loops. Thermal detectors which cannot be reset (fuse-link detectors and the like) may be tested by simulation at the connections of the detectors. Other thermal detectors shall be tested with hot air or similar. Smoke and flame detectors shall be tested as prescribed by the manufacturer.

At least two of the loops shall be checked to ensure that detectability is unimpaired even in the event of breakage of the loop circuit, unless this itself automatically activates the alarm.

2. Sensitivity tests

2.1. Sensitivity tests shall be carried out in accordance with a standard test fire, defined as follows:

An open, rectangular steel vessel measuring $300 \times 300 \times 150$ mm filled with 1 litre of diesel oil and 0.25 kg of cotton waste evenly distributed in the vessel. During the tests, the temperature of the diesel oil shall be at least 50°C and not more than 60°C at the time of ignition.

2.2. Sensitivity tests of the detection system in machinery spaces shall be carried out by placing test fires in various relevant positions in the machinery spaces, the minimum sensitivity requirement being that the system is activated within 3 minutes, irrespective of the position of the test fire.

These tests shall be carried out in at least five different positions, including areas at the top of the main engine(s), the auxiliary engines/generators and oil-fired boilers.

2.3. The sensitivity tests shall be carried out under normal operating conditions, at full speed and full ventilation.

Appendix 5. Procedures for execution of inclining tests and lightweight surveys for Norwegian ships

0 Amended by Regulation of 6 December 2021 No. 3415 (in force on 1 January 2022, previously Appendix 6).

Determination of lightship displacement and centres of gravity

1. Introduction

According to Norwegian regulations on the construction of Norwegian passenger ships, cargo ships and barges, as well as for fishing vessels, the following main principles for the determination and approval of lightship displacement and centres of gravity apply:

- The execution shall be in accordance with procedures laid down by the Norwegian Maritime Authority, and the results shall be entered in the prescribed form.
- The calculations of the lightship data shall be approved by the Norwegian Maritime Authority before the ship is put into service.
- If the design of the ship is such that there is a reason to assume that an inclining test made according to normal procedures will not provide reliable lightship data, the Norwegian Maritime Authority shall be contacted.

The purpose of the following guidelines is to ensure the accuracy of the determined lightship displacement and centres of gravity, and constitutes the procedures referred to above. This document is based on Chapter 7 of IMO Res. A.749(18), "Code on Intact Stability for All Types of Ships Covered by IMO Instruments". Although the mentioned IMO Resolution was primarily written for larger ships, these procedures are also adaptable to ships of less than 24 m in length, when the necessary precautions are taken in order to ensure the accuracy of the test. The Code also contains an annex with more detailed practical guidance. Although not considered an integral part of these guidelines, the Norwegian Maritime Authority recommends that the contents of that annex are studied as additional guidance in connection with the planning of inclining tests and lightweight surveys.

While compliance with the procedures outlined herein will facilitate an expeditious and accurate lightweight survey and inclining test, it is recognised that alternative procedures or arrangements may be equally efficient, and in some cases necessary. However, to avoid delays, all significant deviations from these guidelines must be submitted to the Norwegian Maritime Authority for consideration in reasonable time prior to the execution. Such submissions must be accompanied by proposals for measures to be taken in order to achieve an equivalent level of accuracy.

For cargo ships, except offshore vessels, of 500 gross tonnage and upwards which are registered in the Norwegian International Ship Register (NIS), the ship's classification society is permanently appointed to act on behalf of the Norwegian Maritime Authority. For these ships, deviations from these guidelines shall be forwarded to the classification society for consideration. The classification societies may require documentation in accordance with their own procedures.

As an alternative to these guidelines, Chapter 7 and Annex 1 in IMO Res. A.749(18) may be used if followed in their entirety.

2. Definitions

The Administration: the Norwegian Maritime Authority (NMA).

Approved: Approved by the Norwegian Maritime Authority or whoever is authorised by the NMA.¹

Inclining test: Determining the ship's vertical centre of gravity (VCG) in a given condition, normally by moving a series of known weights in the transverse direction, and then measuring the resulting change in the equilibrium heel angle of the ship. *Lightship condition:* A ship complete in all respects, but without consumables, stores, cargo, crew and effects, and without any liquids on board except that machinery and piping fluids, such as lubricant and hydraulics, are at their normal operating levels.

Lightweight survey: Recording the ship's floating condition and the mass, longitudinal, transverse and vertical location of each item which should be added, deducted or relocated on the ship in its given condition so that the lightship displacement and centre of gravity can be determined from the ship's given condition. Determination of the transverse centre of gravity (TCG) may also be required for ships which are asymmetrical about the centreline or whose internal arrangement or outfitting is such that the ship may develop an inherent list from off-centre weight.

Surveyor: Surveyor from the Norwegian Maritime Authority or another person appointed by and acting on behalf of the Norwegian Maritime Authority.

¹ For cargo ships, except offshore vessels, of 500 gross tonnage and upwards which are registered in the Norwegian International Ship Register (NIS), the ship's classification society is permanently appointed to act on behalf of the Norwegian Maritime Authority.

3. Responsibilities

According to Norwegian regulations, the responsibility for initiating lightweight surveys and inclining tests rests with the yard for ships being constructed or modified in Norway, and with the company if the ship is abroad.

A qualified person shall be in charge of making preparations, conducting the lightweight survey and inclining test, recording the data and calculating the results. This person may be a representative of the yard or the company or a naval architect acting on their behalf. The responsibilities of this person are:

Ascertain that all necessary preparations have been made prior to the arrival of the attending surveyor.

Administrate and coordinate the execution of the lightweight survey and inclining test. Collect complete results from all measurements as soon as these are available.

Prepare results as expediently as possible in order to expose deficiencies and inaccuracies at an early stage.

Submit the final lightweight survey or inclining test report to the surveyor for approval in reasonable time before the planned departure of the ship.

The surveyor shall:

- Attend the survey and note all information relevant for the approval of the final report.
- Approve the report, if the conduct and the results are acceptable.
- The surveyor reserves the right to present the report to the relevant vessel section at the NMA for further evaluation if in doubt.
- Submit to the relevant vessel section at the NMA a copy of the approved report together with a copy of the letter of approval.

In the case of a surveyor appointed on behalf of the NMA (excluding cargo ships of 500 gross tonnage and upwards registered in the Norwegian International Ship Register (NIS)), the surveyor shall:

- Verify that the contents of the report coincides with his own notes and that these procedures were adhered to.
- Submit the report in triplicate to the NMA for approval.

4. Preparations for the lightweight survey

4.1 Request for survey

A surveyor shall be present to witness lightweight surveys and inclining tests, and the results shall be submitted to the attending surveyor for approval.

A request for survey should be sent to the Administration in writing in due time before execution. For ships registered in the Norwegian Ordinary Ship Register (NOR), the request shall be forwarded by the yard to the local NMA station in the case of ships being constructed in Norway and by the company to the NMA head office for ships being constructed abroad.

For cargo ships of 500 gross tonnage and upwards, which are registered in the Norwegian International Ship Register (NIS), the request shall be forwarded to the classification society in accordance with the procedures laid down by the society.

Information to be included in the request

The written request shall contain the following information:

- identification of the ship by name, call sign and/or shipyard hull number;
- date, time, and location of the survey;

inclining weight data, if an inclining test is to be performed:

- type of weights;
- amount (number of units and weight of each);
- certification of mass;
- method of handling (i.e. sliding rail or crane);
- mass and location of righting and/or trimming weights;
- anticipated maximum angle of heel to each side;
- approximate location and length of pendulums;
- details on alternative solutions, if a substitution of a pendulum with an inclinometer or other device is desired;
- anticipated trim;
- anticipated condition of tanks;
- estimated weights to add, deduct or relocate on the ship in order to place the ship in its true lightship condition;
- description of computer software to be used to aid in calculations during the survey;
- name and phone number of the person responsible for conducting the survey.

4.2 General condition of the ship

The ship should be as complete as possible at the time of the lightweight survey, but some flexibility will be acceptable in order to minimize the disruption in the ship's delivery date or its operational commitments. The amount and type of work left to be completed (weights to be added) will nevertheless affect the accuracy of the lightship characteristics, so good judgement should be used. If the weight or centre of gravity of an item to be added cannot be determined with confidence, the uncertainties will be reduced if the item is taken on board prior to the survey.

Temporary material, toolboxes, staging, sand, debris, etc., on board should be reduced to an absolute minimum before the lightweight survey.

All bilge water must be removed.

System piping and system tanks should be filled to their normal operating levels.

All spaces and tanks shall be available for inspection. Manholes leading to void spaces and tanks assumed empty shall be opened. Such spaces and tanks must be ventilated and gas-free to ensure that inspection can take place without danger. An approved explosion-proof testing device to check for sufficient oxygen and absence of lethal gases shall be available for the inspection.

Decks should be free of water. Water trapped on deck during an inclining test may shift and pocket in a fashion similar to free surface effects in a tank. Any rain, snow or ice accumulated on the ship should be removed prior to the test.

A deviation from design trim of up to 1% of L is normally acceptable when using hydrostatic data calculated at design trim. Otherwise, the hydrostatic data should be calculated for the actual trim. Caution should be exercised when applying this "1 per cent rule of thumb" to ensure that excessive error, as would result from a significant change in the waterplane area due to heel, is not introduced into the stability calculations.

The specific gravity of the seawater should be accurately recorded.

4.3 Tanks

The anticipated liquid loading for a lightweight survey must be included in the planning for the survey. Preferably, tanks should be empty and clean, or completely full. The number of filled-up tanks should be reduced as far as practicable. When a lightweight survey has been accepted as replacement for an inclining test on newbuildings, the limitations of tank contents as given in 4.5 below apply.

Filled-up tanks shall not contain air pockets caused by trim or inappropriate location of ventilation pipes. Less than 100% full tanks (for example 98% as often used for loading conditions) are not acceptable. Before tanks are sounded, the ship should be heeled to both sides trimmed as necessary to avoid air pockets.

A list of the planned contents of each tank during the lightweight survey shall be submitted to the surveyor in ample time prior to the execution. This list shall also provide the necessary information regarding the procedures for verifying the tanks' contents and their centres of gravity.

If the total tank contents exceed 20% of the ship's displacement, the specific gravity of these contents must be verified by measurement.

Connections, including manifolds, between tanks containing liquid shall be closed prior to the survey, and their controls secured in order to avoid unintended operation.

Notwithstanding these limitations, it must be assured that the tank contents are sufficient to obtain adequate stability during measurements.

4.4 Draught measurements

Prior to the survey, the depth of water should be measured and recorded in as many locations as are necessary to ensure that the ship will not touch the bottom.

Draughts and freeboard shall be measured prior to the survey and in the case of an inclining test immediately before the weight movements. The measurements should be checked after the survey to verify that there have not been any changes in draught and trim during the survey or inclining test.

Whenever possible, a dinghy should be available for the draught and freeboard measurements. To avoid the effects of surge the draught readings may be taken with the help of a transparent plastic tube, throttled in the submerged end.

As a minimum, draughts shall be measured at the fore and aft draught marks in addition to measuring the freeboard amidships at both sides. For large ships, or whenever a hogging or sagging condition may be expected, additional freeboard readings should be taken approximately halfway between amidships and the fore and aft draught marks.

If correct application of the draught marks has not been previously verified, additional freeboard readings should be taken, preferably at the draught marks if the hull shape so permits.

In case of trim, the longitudinal position of all readings must be verified in order to correct the values relative to the reference planes used in the ship's hydrostatic calculations. The longitudinal position of freeboard readings must always be carefully verified for ships with sheer.

If the ship has substantial trim, all vertical readings may need correction with respect to the trim angle in order to coincide with the definition of draught for trimmed waterlines in the hydrostatic calculations.

If freeboards are not measured from the deck corner, the vertical reference point must be checked and noted.

4.5 Additional requirements for inclining tests

Movable items

Excess crew or personnel not directly involved in an inclining test shall not be on board the ship during the test.

All items which may swing or shift must be secured. Cranes, derricks, forklifts etc. shall be stowed and secured in their seagoing position.

Hatch covers etc. not needed open during the test shall be fixed in their seagoing position.

The number of slack tanks should be kept to an absolute minimum. The viscosity of the fluid, the depth of the fluid and the shape of the tank should be such that the free surface effect can be accurately determined.

Normally, just one or two of the following kinds will be accepted partly filled:

- freshwater tank
- fuel oil tank
- fuel oil service tank

In order to obtain reliable free surface corrections, slack tanks, if any, should be filled within these limits:

- Deep tanks: 20-80 per cent full
- Double bottom tanks: 40-60 per cent full

Tanks not intended to contain liquid shall be completely empty.

The number of filled-up tanks shall be reduced to the minimum that is necessary to maintain sufficient stability during the test.

Moorings

The ship should be moored in a quiet, sheltered area free from extraneous forces such as waves and propeller wash from passing vessels or sudden discharges from shore side pumps. The tide conditions and the trim of the ship during the test should be taken into account. The ship should be moored in a manner to allow unrestricted heeling. The access ramps should be removed. Power lines, hoses, etc., connected to shore should be at a minimum, and kept slack at all times.

The ship should be as upright as possible and have sufficient draught so that any abrupt changes in the waterplane will be avoided, as the ship is inclined from side to side. With inclining weights in the initial position, up to one-half degree of list is acceptable.

Inclining weights

The total weight used should preferably be sufficient to provide a minimum inclination of 2 degrees and a maximum of 4 degrees of heel to each side. However, a minimum inclination of 1.5 degrees to each side may be accepted for large ships such as tankers and bulk carriers.

Test weights should be compact and of such a configuration that the VCG (vertical centre of gravity) of the weights can be accurately determined. Each weight should be marked with an identification number and its mass. If reliable information on the weights cannot be presented to the surveyor, re-certification of the test weights should be carried out prior to the test.

Inclining weights made of porous material which may absorb water must always be weighed prior to the test, and their use should only be accepted if the conditions are such that no further absorption may occur.

A crane of sufficient capacity and reach, or some other means, should be available during the inclining test to shift weights on the deck in an expeditious and safe manner. Using the ship's own cranes or derricks is normally not acceptable.

Water ballast is generally not acceptable as inclining weights. However, for large ships, water ballast transfer between tanks of a right-sided shape may be permitted, subject to prior consent by the Administration, and only when it is absolutely impractical to incline using solid weights. In such cases, accurate sounding tables are of vital importance. The specific gravity of the ballast water in such tanks must be accurately recorded, and ballast line branches not necessary for the conduct should be blind-flanged.

Pendulums

A minimum of two pendulums should be used to allow identification of bad readings at any one pendulum station. They should each be located in an area protected from the wind.

The pendulums should be long enough to give a measured deflection, to each side of upright, of at least 15 cm. To ensure that recordings from individual instruments are kept separate, it is suggested that the pendulums be physically located as far apart as practicable.

The use of an inclinometer or U-tube may be considered in each separate case. Inclinometers or other measuring devices may, however, only be used in conjunction with at least one pendulum.

Efficient two-way communications should be provided between a central control station and the weight handlers and between the central control station and each pendulum station. One person at the central control station should have complete control over all personnel involved in the test.

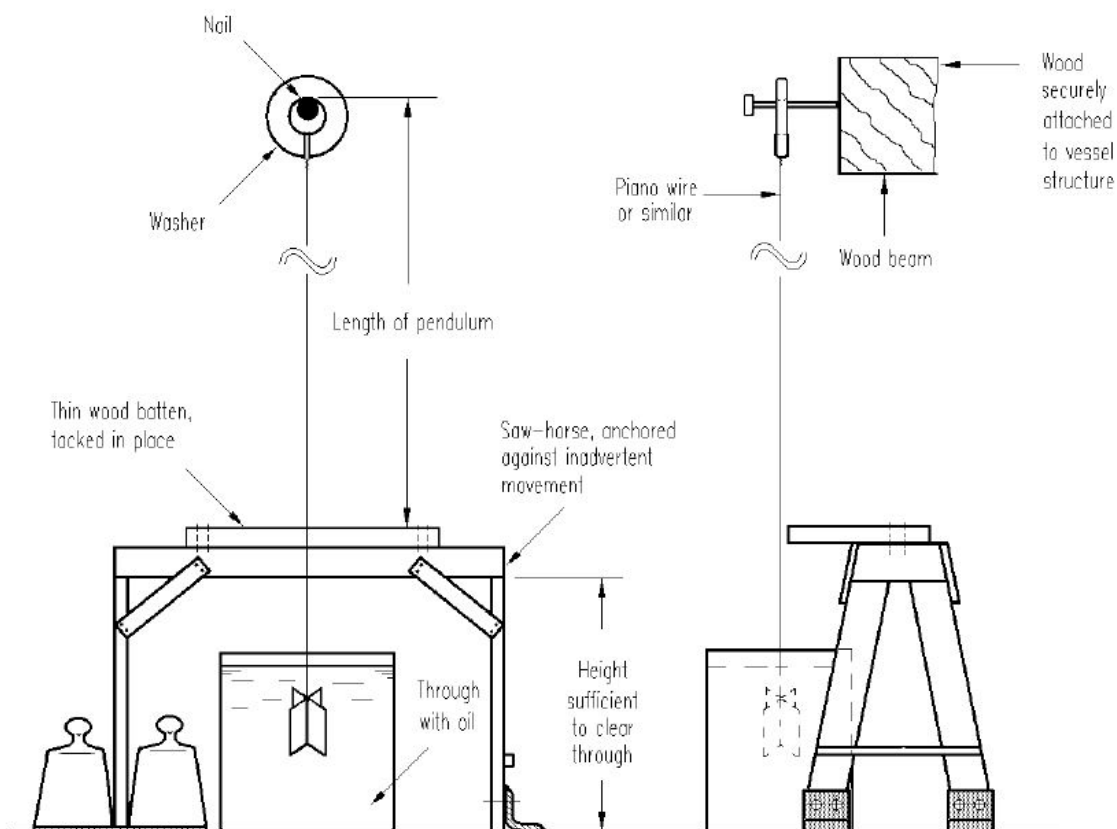

Fig. 1 Recommended set-up of pendulums

Use of U-tube

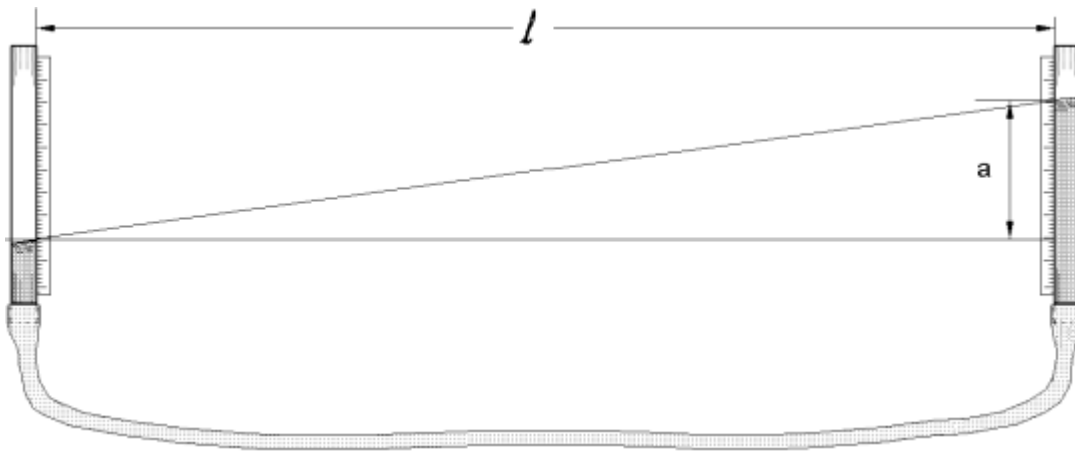

Fig. 2 Reading of U-tube

Where a U-tube is used as a substitute for a pendulum the following must be complied with:

- The vertical ends of the device should be securely positioned as far outboard as possible. In any case shall the horizontal distance between the ends be sufficient to obtain a level difference of at least 15 cm between the upright and the maximum inclination to each side.
- It must be assured that the vertical ends are long enough to ensure that at maximum inclinations the water level will neither overflow nor disappear from the vertical ends.
- Fixed arrangements must be made for recording all readings at both ends.
- Clear plastic tube or hose must be used throughout in order to check for air pockets.

A small amount of ink or dye may be added to the water in the device for improved visibility.

Inclinometers

A copy of a calibration certificate from an institution acceptable to the Administration must be delivered to the surveyor prior to the test. As an additional confirmation, the inclinations obtained from the device must coincide with those from a pendulum.

The accuracy of the instrument should be in the order of ± 0.01 degrees.

4.6 Plans required

The person in charge of the inclining test should have available a copy of the following plans at the time of the inclining test:

- lines drawing
- hydrostatic data
- general arrangement plan of decks, holds, inner bottoms, etc.
- capacity plan showing capacities and vertical and longitudinal centres of gravity of cargo spaces, tanks, etc.
- sounding tables
- draught mark locations
- docking drawing with keel profile and draught mark corrections (if available)

5. Conducting an inclining test

5.1 Requirements

The standard test employs at least eight distinct weight movements where movement no. 8 shall be a recheck of the zero point. The tangent to the accumulated pendulum deflection and the accumulated inclining moment shall be plotted in a diagram after each movement. The weight movements shall be such as to obtain distinct

intermediate values between the zero point and the maximum deflections to each side in order to demonstrate linearity.

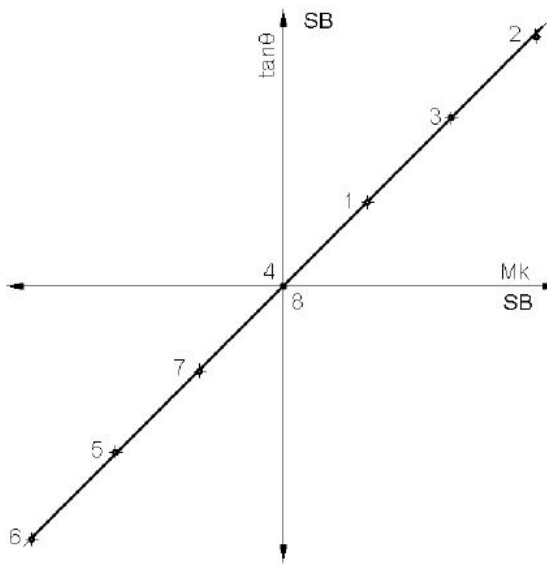

Fig. 3 Recommended sequence

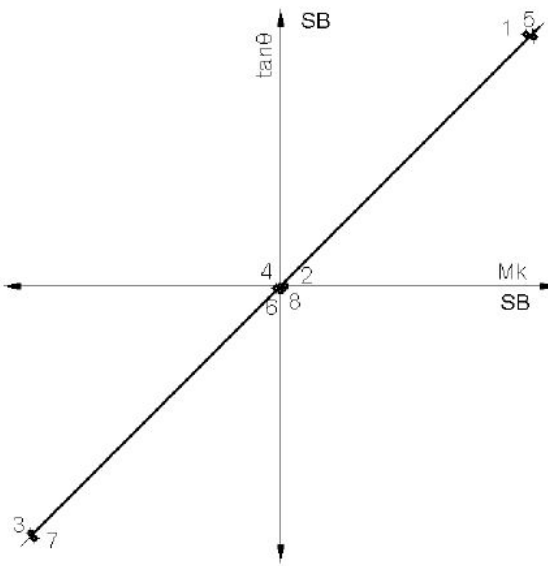

Fig. 4 Unacceptable distribution of points

The inclining test will not be complete until 8 acceptable plotted points have been achieved. If a reasonably straight-line plot is not obtained, those weight movements that did not yield acceptable plotted points should be repeated or the error source should be identified and corrected.

Disregarding plots and determining the ship's metacentric height by calculation alone (such as mean value of single values or "the least square method") is unacceptable, as errors and deviations may become hidden in the results.

Unfavourable weather and sea conditions may lead to an unacceptable degree of accuracy caused by for instance difficulties obtaining accurate draught and freeboard measurements, irregular pendulum readings and variable external moments. If the ambient conditions are such that there is reason to believe that accurate results cannot be obtained, the test shall be postponed if it is not possible to move the ship to a better location. Failure to achieve a straight line plot under such conditions should be taken as an indication that satisfactory results may not be possible.

It is required that inclination measurements are taken at least at 2 independent stations. If the plots from these stations do not coincide, the reason must be found, corrected and the test repeated or postponed as appropriate. If more than 2 stations are used, the results will be acceptable if 2 of those stations coincide.

A copy of the inclining data should be forwarded to the surveyor along with the calculated results of the inclining test in a report format laid down by the Norwegian Maritime Authority. Unless otherwise agreed, the NMA standard form "Report on inclining test and calculation of lightship data" (Report 79) shall be used.

All calculations performed during the inclining test and in preparation of an inclining test report may be carried out by a suitable computer program. Output generated by such a program may be used for presentation of all or partial data and calculations included in the test report if it is clear, concise, well documented, and generally consistent in form and content with the standard form.

5.2 Interpretation of plotted readings

Shown in the following figures are some examples on failure to achieve correct plots, including probable causes and suggested measures to be taken.

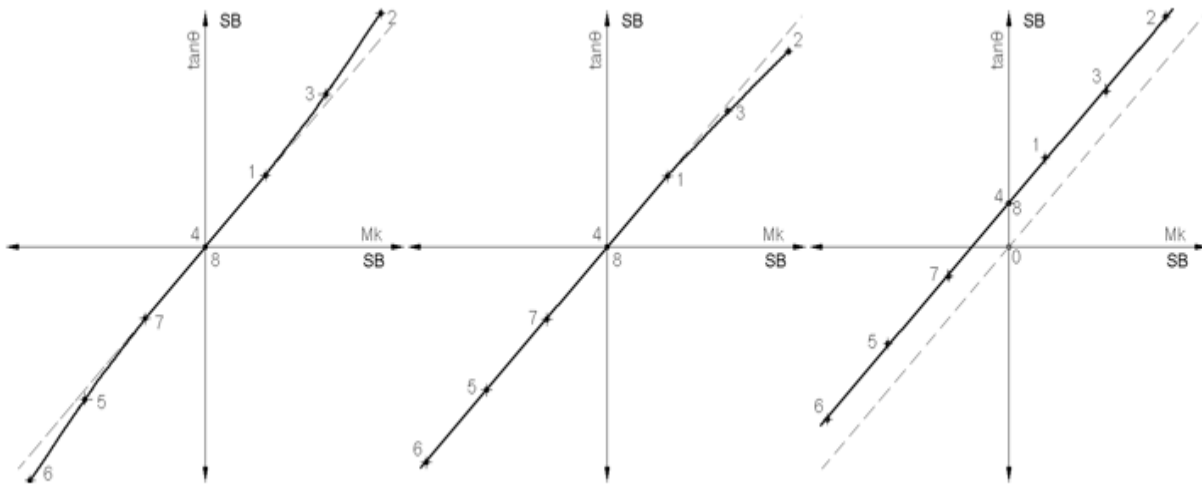

Fig. 5

Fig. 6

Fig. 7

Fig. 5: Excessive free liquids. Re-check all tanks, cofferdams and the tank top. Pump out or top up as necessary. Re-do all weight movements and re-check freeboard and draught readings.

Fig. 6: Ship touching bottom or pier, alternatively restrained by mooring lines. Take water soundings and check lines. Re-do weight movements 2 and 3.

Fig. 7: Steady wind from port side came up after initial zero point taken. This plot is acceptable.

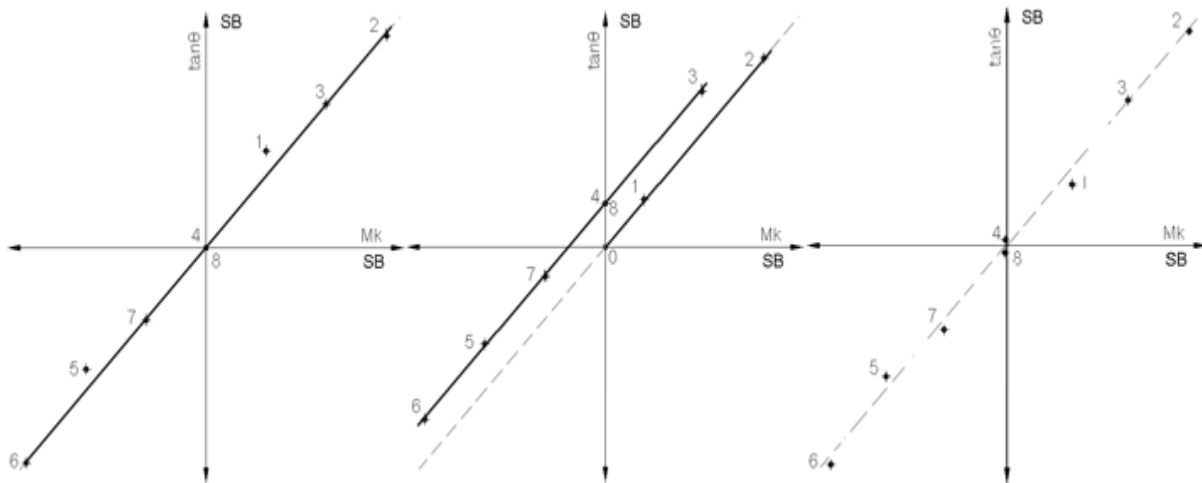

Fig. 8

Fig. 9

Fig. 10

Fig. 8: Gusty wind from port side. Re-do weight movements 1 and 5.

Fig. 9: On one pendulum only: Measurement scaffolding or pendulum anchoring-point shifted between movements 2 and 3. Use data from the other pendulum(s) if a straight line was obtained there and the slopes of all lines coincide. On all pendulums: Probably wind as on Fig. 7.

Fig. 10: Random variances: If the deviations cannot be related to specific causes, add extra movements to both sides until improved significance is obtained. The slope for all pendulums must coincide.

5.3 Special considerations if a U-tube is used

The device shall be thoroughly checked for air pockets immediately prior to the test.

The water levels in both ends shall be recorded for all movements, and the differences compared to ensure that no water has leaked from the device. Since, as opposed to a pendulum, U-tubes must be read at two sites

for each movement extra care is necessary in order to maintain a constant heeling moment when the personnel is moving about.

If a valve or similar is added to the device to choke the flow in order to dampen the effect of oscillation, sufficient time must be allowed for equalization before each reading.

Appendix 6. Report on inclining test and calculation of lightship data

0 Amended by Regulation of 6 December 2021 No. 3415 (in force on 1 January 2022, previously Appendix 7).

To read the report form, click here:

1. General information

See point 3 Other information

2. Ship particulars

See point 3 Other information

3. Other information

Click here to read points 1-3:

4. Draught readings

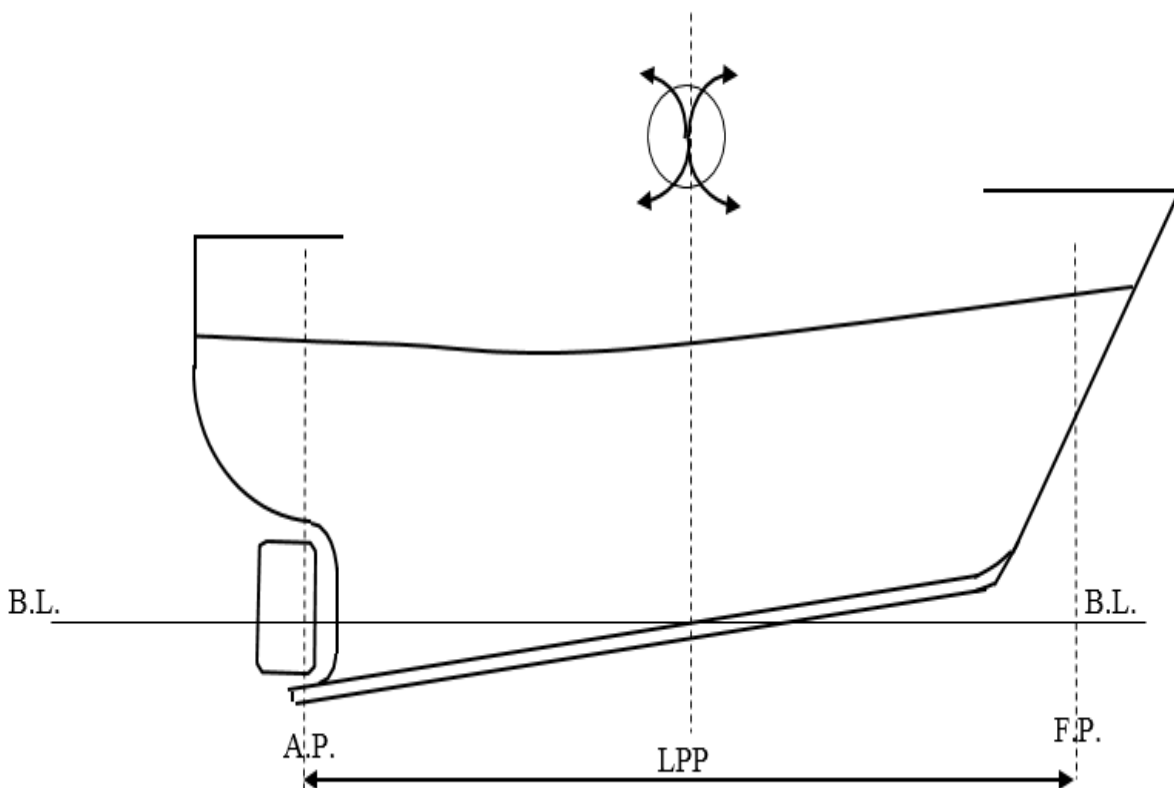

Fig. 1

Please indicate the following on the sketches:

1. Base line and longitudinal reference point used in the hydrostatic data
2. Location of draught marks fore and aft (Fig. 1)

3. Draught readings at marks
4. Freeboard readings fore and aft (Fig. 1)
5. Freeboard readings, starboard and port side (Fig. 2 or Fig. 3)
6. Longitudinal, transverse and vertical location of other reference points, if any
7. Readings at other reference points, if any

Note:

If the ship has trim during the test, care must be taken to ensure that the readings are taken as perpendicular as possible to the base line (parallel to the frame) and not perpendicular to the waterline. The readings may as an alternative be corrected for trim.

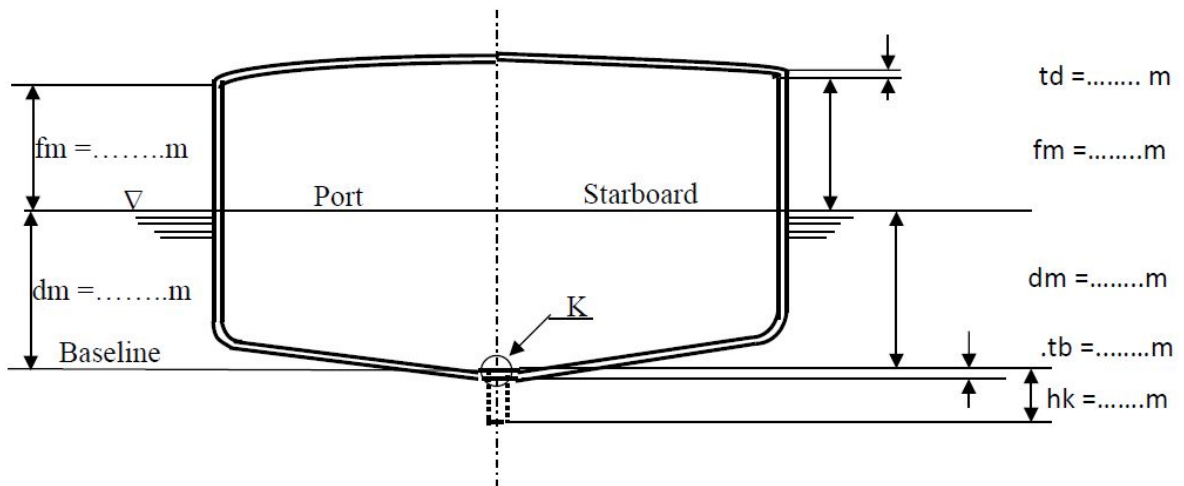
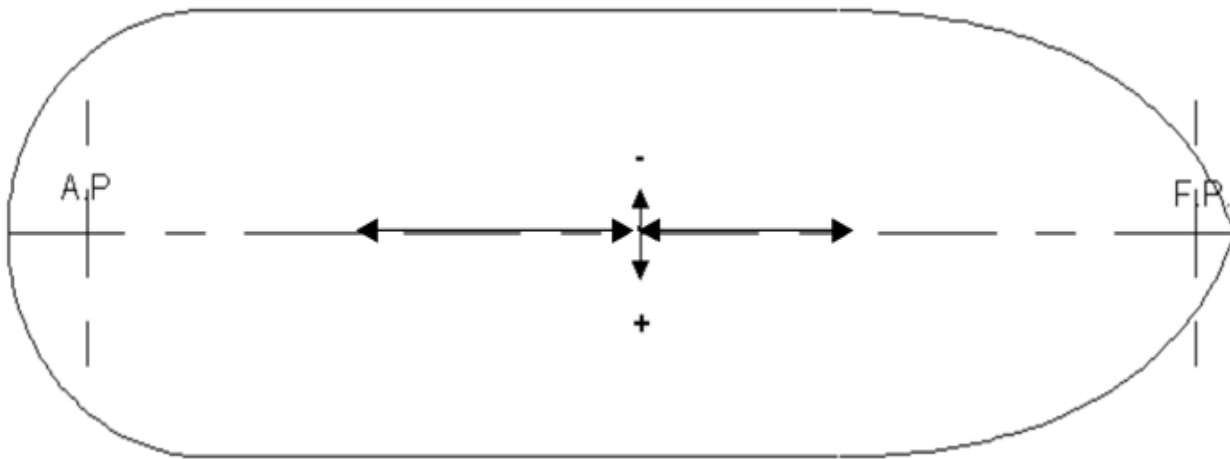

Fig. 2

Ship with shell plating

Longitudinal position of this section, if not at LBP/2: _____ m from: _____

Measurement of depth moulded at this section, if taken: SB: _____ m PS: _____ m



Placement of weights prior to first movement (longitudinal and transverse)

7. Pendulums

<i>Pendulum No.</i>	<i>Length</i>	<i>Location</i>

Note: If a pendulum is replaced by a U-tube or similar device the transverse distance between the measuring posts is indicated as “length” in above table. A sketch of the arrangement shall be enclosed with the report.

8. Tank contents for deduction

Click here to read point 8:

9. Succession of weight movements

<i>Movement No.</i>	<i>Direction, indicate with arrows</i>			<i>Weight No(s). moved</i>
	<i>PS (-)</i>	<i>C.L.</i>	<i>SB (+)</i>	
0				
1				
2				
3				
4				
5				
6				
7				
8				
9				
10				
11				
12				
13				
14				
15				

10. General requirements for conduction of the test

The following items shall be checked and found in order by the person in charge of the test before this report is submitted to the surveyor for approval:

1. The deflections shall be measured at at least two (2) stations, of which at least one shall be a pendulum.
2. List before first movement shall be as small as possible. The results will not be acceptable without exact calculation of the righting moment(s) if the sum of list and inclination exceeds 5° to one side.
3. The test will not be approved if, due to list, the ship has not been inclined beyond the upright position.
4. Maximum deflection to both sides shall be 2°-4°. For large ships (tankers, bulk carriers, etc.), 1.5° may be accepted.

For unconventional designs and ships with especially large initial stability (GM_T) other values may be permitted subject to acceptance prior to the test.

5. Pendulum length and maximum heeling moment applied shall be so adjusted that maximum deflection read is not less than 150 mm.
6. For the test to be approved, at least eight (8) successful readings, including the starting point, shall be obtained and these readings shall lie on an approximately straight line for all measuring stations.
7. The difference between actual trim and the trim in the hydrostatic data used shall not exceed 0.01*LBP.

11. Measured metacentric height for the ship as inclined

Click here to read point 11:

Use positive sign for (3), (6) and (9) when moving weights towards SB. Negative sign when moving towards PS. Accumulated Tan Φ shall be plotted successively during the test, as a function of accumulated moment.

12. Results from the inclining test

KM _T for trimmed waterline		m
Measured GM _T , pendulum 1	m m m]	
Measured GM _T , pendulum 2		
[Measured GM _T , pendulum 3		
Average GM _T		m
Correction for free surface in tanks	+	m
Vertical centre of gravity above baseline for the ship as inclined		m

If the hydrostatic data is calculated for actual trim during test:

$$LCG = LCB - (VCG - VCB) \frac{t}{L_{pp}} = \quad m$$

(Trim by stern taken as negative)

If the hydrostatic data is interpolated from curves/tables:

$$MCT1 = \frac{(KML - VCG) * \Delta}{100 * LBP} = \quad \text{tm/cm}$$

Longitudinal centre of gravity:

$$LCG = LCB - \frac{t * MCT1_{cm} * 100}{\Delta} = \quad m$$

(Trim by stern taken as negative)

Calculation of LCG

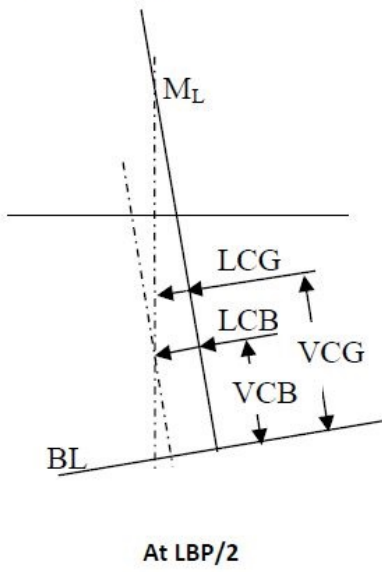

Graphical method which should be used for calculation of GM

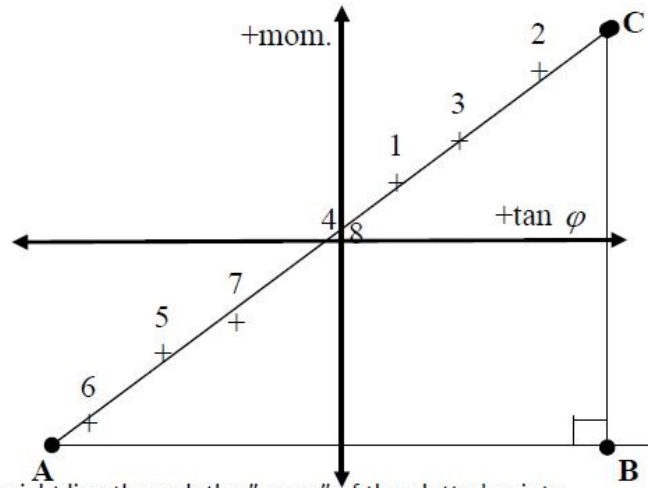

Draw a straight line through the "mean" of the plotted points.
Mark two arbitrary points A og C as far apart as possible on the straight line

$$GM = \frac{BC(tm)}{AB * \Delta(t)}$$

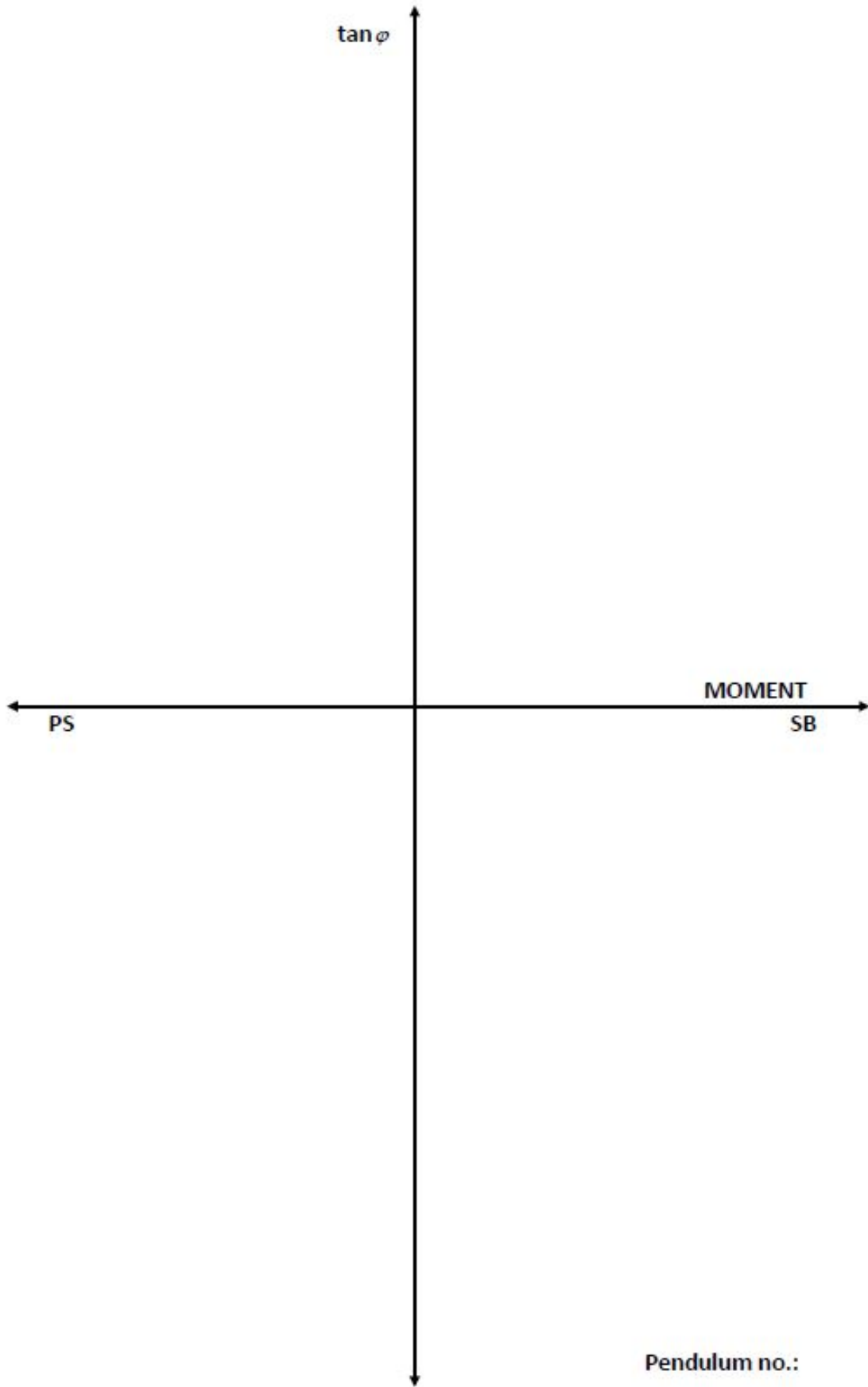

Pendulum no.:

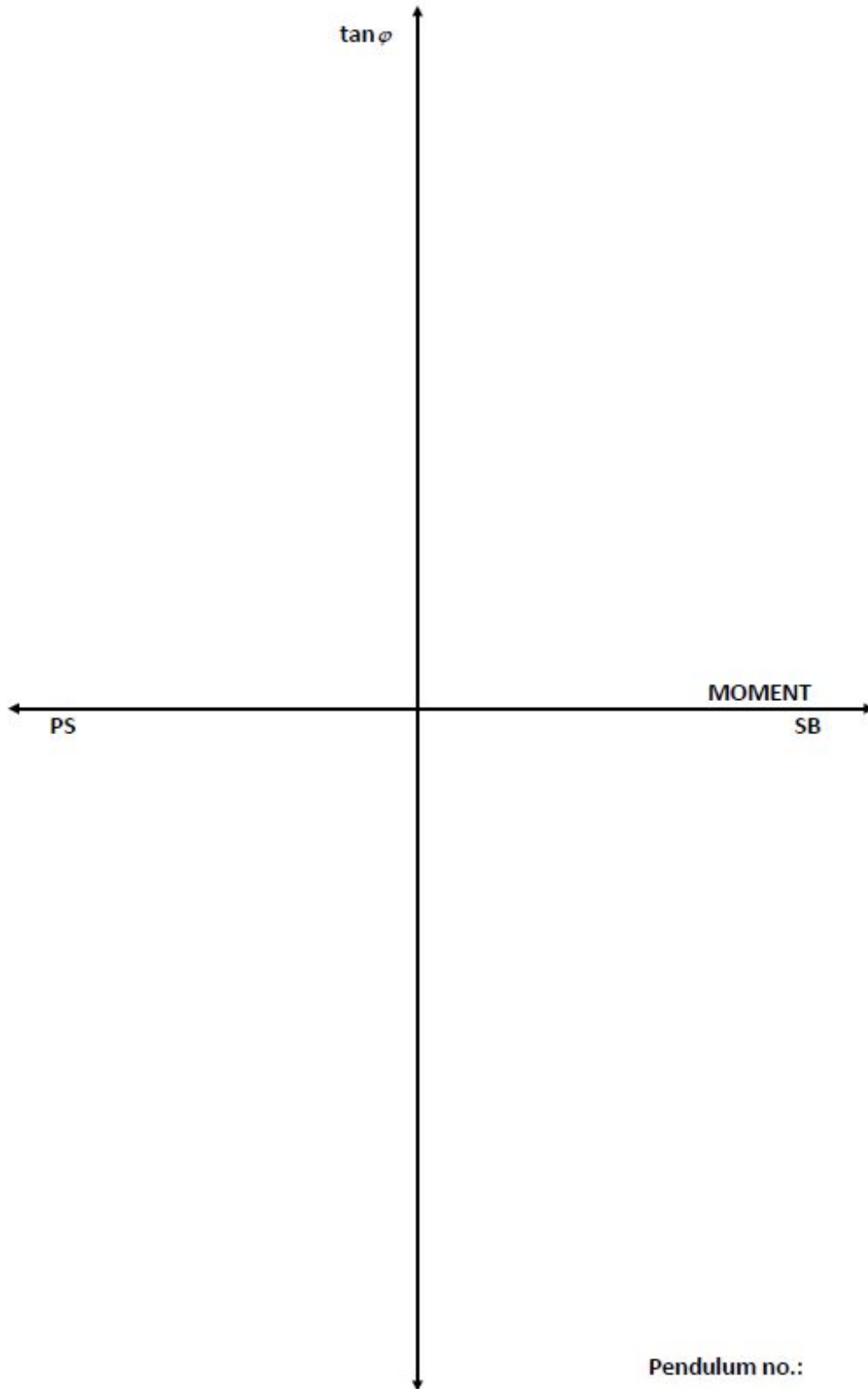

13. Calculation of lightship

[Click here to read point 13:](#)

14. Particular weights included in the lightship

The calculated lightship shall exclude cargo, fuel, lubricating oil, water ballast or other fluid or pumpable ballast, potable water, feed water, sewage, provision and other consumables as well as crew, passengers and

their effects. However, the minimum amount of mooring equipment, spares, etc., required by the Norwegian Maritime Authority or the classification society as well as the minimum amount of water in boilers, system oil in piping, etc., is to be included in the lightship.

The lightship data calculated in this report includes the following items related to special operations and shall not be included in the ship's loading conditions:

<i>Item</i>	Weight <i>(tonnes)</i>	<i>C.G. above</i> B.L. <i>(m)</i>	<i>C.G. from</i> LBP/2 <i>(m)</i>	<i>Values are checked</i>	
				<i>Yes</i>	<i>No</i>
Total weight					

Note: In this table items such as fishing gear, towing gear, fixed hotel appliances, removable modules and solid movable ballast which may be taken ashore in case of change of operation shall be specified.

Comments to the inclining test:

Appendix 7. Functional requirements for BNWAS

0 Amended by Regulation of 6 December 2021 No. 3415 (in force on 1 January 2022, previously Appendix 8).

Vessels which are fitted with automatic pilot system / steering aids and have vessel instructions for a trade area larger than Fjord fishing shall be provided with a bridge navigational watch alarm system (BNWAS). Alarms which are not type-approved in accordance with IMO Res. MSC.128(75) shall satisfy the following functional requirements:

1. Description of system
 - 1.1. Operation, programming, etc.

The BNWAS shall be connected to the main source of energy for starting the vessel's main engine or the main engine's alarm/monitoring system, and shall be automatically switched on when the vessel's main engine is started.

The BNWAS shall be activated when the load on the vessel's main engine or the pitch of the propeller corresponds to the vessel's service speed. When connection to the main engine could be problematic, the BNWAS may alternatively be connected to a GPS or other reliable instruments which can provide information on the vessel's speed, if they are automatically switched on when the main engine is started, and the BNWAS is activated when the vessel reaches 70 per cent of its service speed. The alarm shall be activated if instruments providing information about speed do not switch on when the main engine is started.

The BNWAS shall trigger an audible alarm signal within a time interval not exceeding five minutes if the person in charge does not acknowledge his or her presence in the wheelhouse. Upon acknowledgement a new time interval shall start.

Acknowledgement shall take place either by the person in charge of the navigational watch pressing a reset button, or by moving the manual steering device. An IR sensor based on movement and with a heat-seeking function may be used as additional equipment if this does not impair the function of the BNWAS.

1.2. Alarm functions

- Alarms shall be triggered in two steps.
- The first step shall be triggered in the wheelhouse.
- The second step shall be triggered in the wheelhouse and in the accommodation.
- Shortly before the alarm is triggered, a light signal shall be exhibited to notify that an alarm will be triggered.

1.3. Start

When the BNWAS is operable, this shall be indicated. Malfunctions of connections to alarm horn shall be indicated specially.

2. Installation

2.1. Placement of control unit

The BNWAS shall be so placed that it is clearly visible for the person in charge in the wheelhouse.

2.2. Number of alarm horns

At least one alarm horn shall be installed in the wheelhouse, and at least one alarm horn in the accommodation.

2.3. Electrical connection

A cable approved for low-voltage use on ships shall always be used for the installation. Power supply shall be provided from a fused circuit over the main switch for the main engine. The cable dimension shall be in accordance with the maximum power drain from the BNWAS.

2.4. Connection

The BNWAS shall be so coupled that the unit is always connected to voltage when the vessel's main engine is running, or when the vessel's propeller is connected. When the BNWAS is connected and operable, this shall be indicated as described in paragraph 1.3.

2.5. Programming and function control

The programming of time intervals for alarm triggering shall be carried out by the manufacturer/supplier. The manufacturer/supplier shall check the installation and carry out a functional test of the BNWAS after the programming.

3. Maintenance

The BNWAS shall not need periodical maintenance.

4. Information about the system

4.1. Information from the manufacturer/supplier

The following information shall be provided by the manufacturer/supplier:

- description of the system's operating principles
- description of alarm functions
- frame diagram of the BNWAS describing how the system is structured, with the names of the various components
- instructions for use in Norwegian.

4.2. Posting of instructions for use

The BNWAS' instructions for use shall either be posted on board or be readily available for the person in charge of the navigational watch.

Appendix 8. Water on deck

1. Vessels shall be able to withstand the effect of water on deck, taking account of the seasonal weather and sea conditions of the waters in which the vessel will operate, the type of vessel and its mode of operation.
2. Flooding of decks and open spaces
 - 2.1 For vessels so arranged as to allow water to accumulate in open depressions on weather-exposed decks, the stability calculations shall take account of the effect of such flooding, cf. subsection (3).
 - 2.2 For vessels in which hatches and similar openings must periodically remain open during operation, calculations shall be made of the vessel's stability after the flooding of the space or spaces that may be flooded, if the angle of flooding for the opening concerned is less than 30 degrees.
3. The vessel's ability to withstand the heeling effect caused by flooding of decks and open spaces
 - 3.1 The vessel's ability to withstand the heeling effect caused by water on deck may be shown by a quasi-static method with reference to the below figure, when the following requirements are met with the vessel in the least favourable operating condition:

The relation $C_v = [\text{areal } b / \text{area } a]$ shall not be less than 1.

- 3.2 The angle limiting the area "b" shall be equal to the angle of flooding θ_f or 40 degrees, whichever is the smaller.
- 3.3 The value of the heeling moment M_v or the corresponding heeling lever, caused by water on deck shall be determined by assuming that the deck depression is filled to the top of the lowest point of the bulwark or to the point of flooding 1 for an open space and that the vessel is heeling to the angle θ_d where this point is submerged.
- 3.4 The curve for the heeling moment or the corresponding heeling lever is terminated for the angle at which the lowest point of the bulwark or the point of flooding is submerged. In calculating M_v the following conditions shall be met:
 - a. Initially, the vessel is upright.
 - b. When heeling the vessel's trim and displacements are constant and equal to the values for the vessel without water on deck.
 - c. The effect of freeing ports shall be disregarded.
 - d. M_v shall be calculated for a sufficient number of angles for each draught and normally for waterlines without trim only.

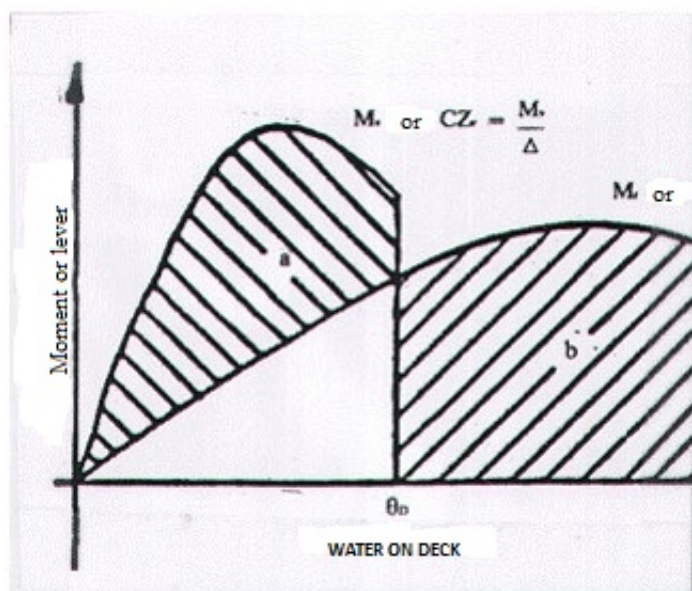

4. Other methods for calculating the effect of water on deck may be used.